

Flavor: implications of LHC measurements and future prospects

Gino Isidori

[*University of Zürich*]

- ▶ Introduction [*Open problems, common lore, recent hopes*]
- ▶ Bottom-up approaches to describe the anomalies
- ▶ Speculations on UV completions
- ▶ Possible future implications
- ▶ Conclusions

► Introduction

The Standard Model has proven to be successful over an unprecedented range of energies. However, despite all its phenomenological successes, this Theory has some deep unsolved problems:

EW hierarchy problem

Flavor puzzle

Neutrino masses

U(1) charges

Strong CP problem

Dark-matter

Dark-energy

Inflation

Matter-antim. Asym.

Quantum gravity



The SM should be regarded as an effective theory, i.e. the limit –*in the accessible range of energies and effective couplings*– of a more fundamental theory, with new degrees of freedom



► Introduction

The Standard Model has proven to be successful over an unprecedented range of energies. However, despite all its phenomenological successes, this Theory has some deep unsolved problems:

	<i>problem associated to...</i>
EW hierarchy problem	→ <u>Fermi scale</u>
Flavor puzzle Neutrino masses U(1) charges Strong CP problem	→ <u>No specific energy scale</u> (fine tuning of the model parameters)
Dark-matter Dark-energy Inflation Matter-antim. Asym.	→ <u>Cosmological implementation of the SM</u>
Quantum gravity	→ <u>General problem of any QFTs</u>

► Introduction

This “main avenue” has led to very appealing BMS constructions...

EW hierarchy problem → Fermi scale

Flavor puzzle

Neutrino masses

U(1) charges

Strong CP problem

“Common lore” (I) :

Dark-matter

Dark-energy

Inflation

Matter-antim. Asym.

Quantum gravity

$$\mathcal{L}_{\text{SM}} = \mathcal{L}_{\text{gauge}}(A_a, \Psi_i) + \mathcal{L}_{\text{Higgs}}(\phi, A_a, \Psi_i)$$



Understanding what **stabilizes the Higgs sector** (*EW hierarchy problem*) is the natural “main avenue” to discover New Physics

► Introduction

This “main avenue” has led to very appealing BMS constructions...

...however, so far these do not find experimental confirmation (*making these theories less and less appealing...*) → worth to explore new directions.

EW hierarchy problem

Flavor puzzle

Neutrino masses

U(1) charges

Strong CP problem

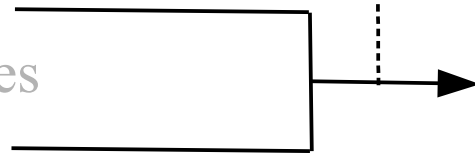

A direction which seems to be
suggested by recent b-physics data ...

Dark-matter

Dark-energy

Inflation

Matter-antim. Asym.

Quantum gravity

► Introduction [*the flavor structure of the SM*]

The SM flavor sector (= *the Yukawa sector*) contains a large number of free parameters (fermion masses & mixing angles), which *do not look at all accidental...*

E.g.:

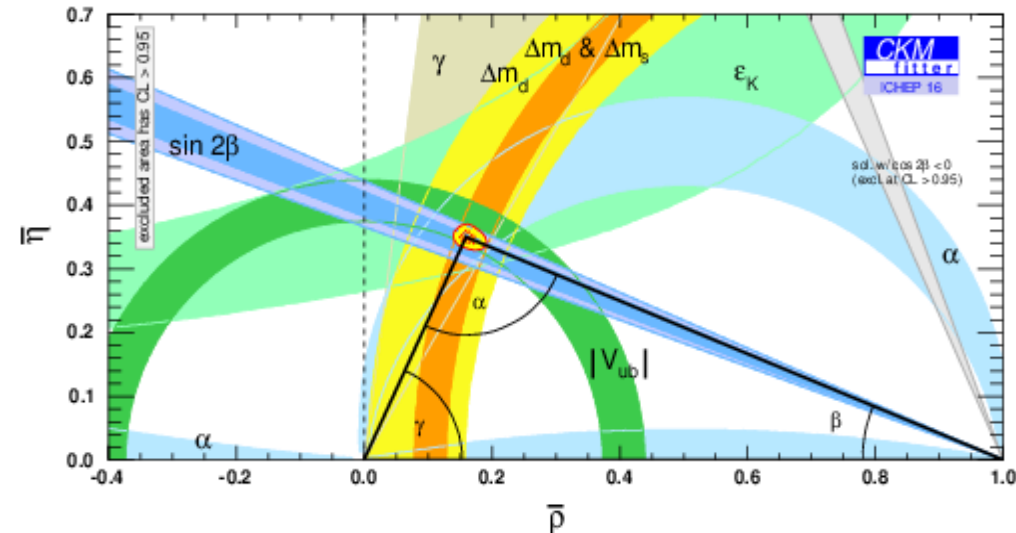
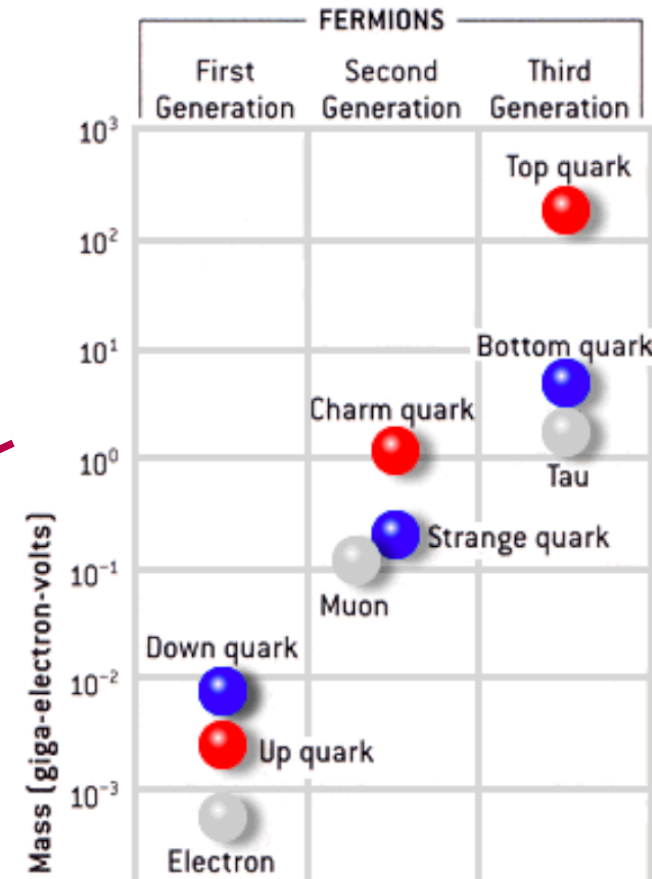
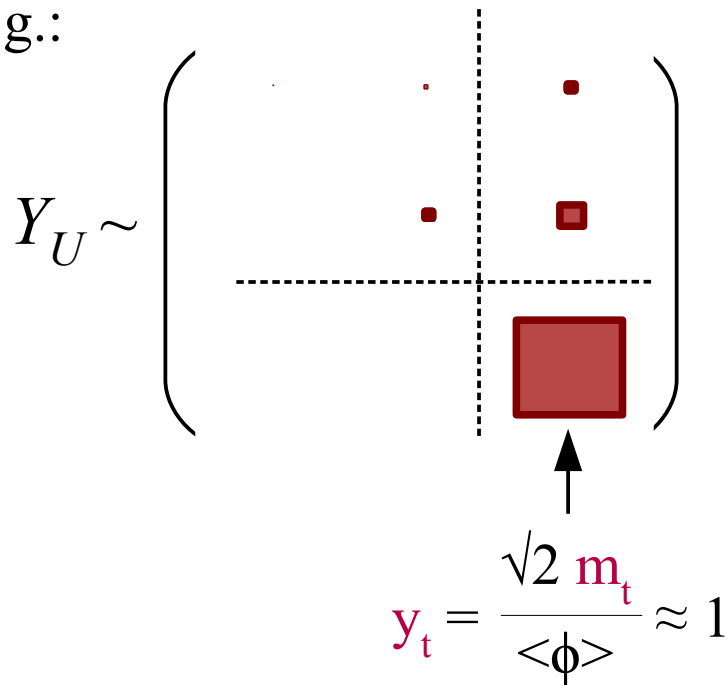

The “old” flavor puzzle...

► Introduction [*the flavor structure of the SM & beyond*]

“Common lore” (II) :

The flavor structures are generated at some very heavy energy scale → *No chance to probe their dynamical origin*

This idea ~~is~~ was supported by considering the SM as an effective theory, trying to determine the NP impact on rare flavor-changing processes:

$$\mathcal{L}_{\text{eff}} = \mathcal{L}_{\text{SM}} + \sum_n \frac{c_n}{\Lambda^2} \mathcal{O}_n^{\text{d}=6}$$

Possible large impact in processes such as meson-antimeson mixing which are in good agreement with the SM predictions

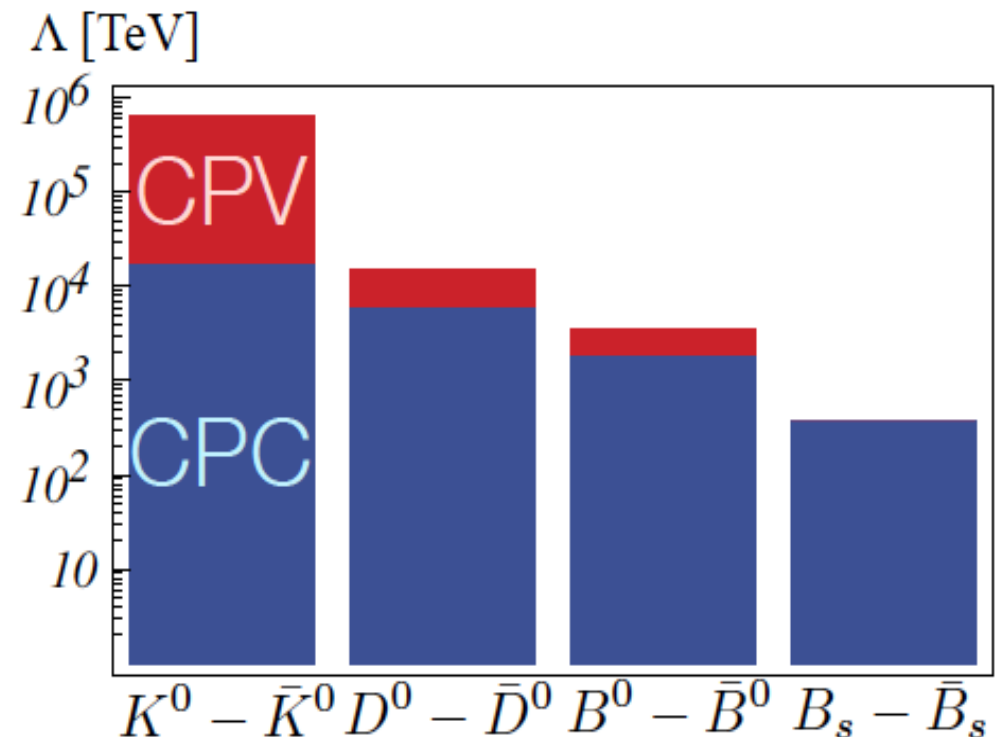

► Introduction [*the recent hopes...*]

This point of view is challenged by the recent “anomalies” in B physics, i.e. the observation of a different (*non-universal*) behavior of different lepton species in specific semi-leptonic processes:

- (I) $b \rightarrow c$ charged currents: τ vs. light leptons (μ, e)
- (II) $b \rightarrow s$ neutral currents: μ vs. e

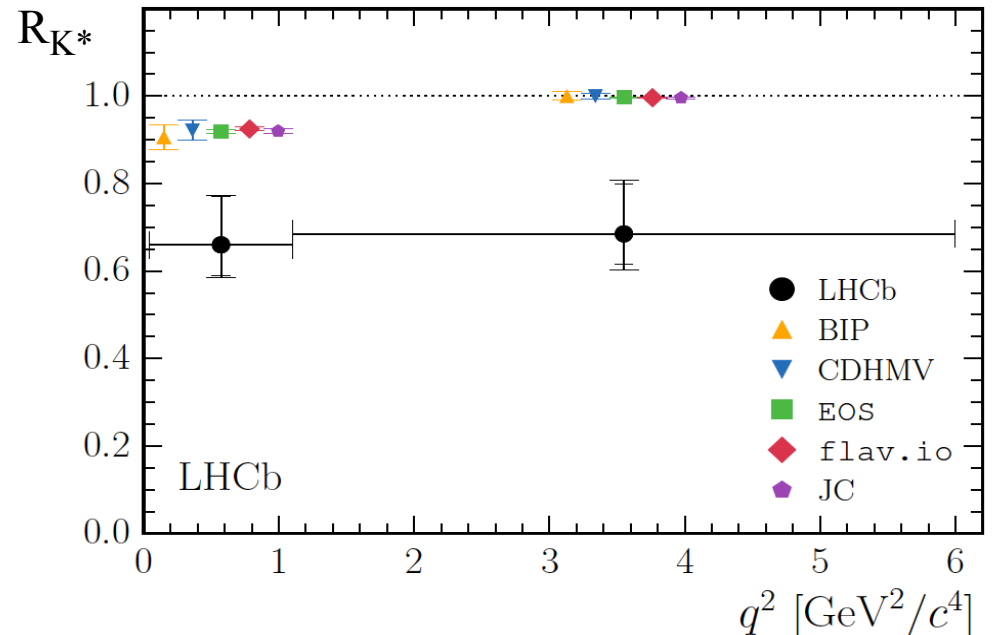
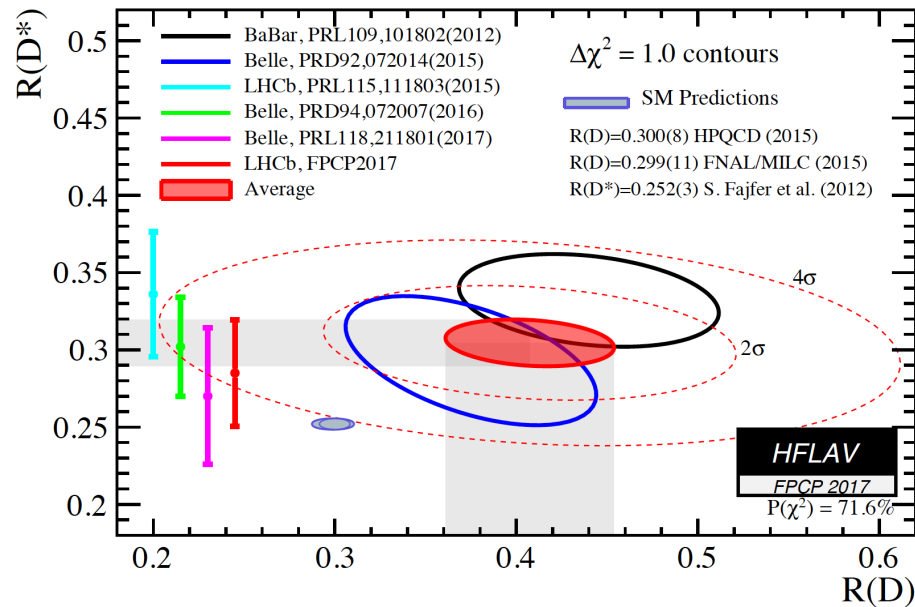

► Introduction [the recent hopes... (I) $b \rightarrow c \ell \bar{\nu}$]

Test of **LFU** in charged currents
[τ vs. light leptons (μ, e)]:

$$R(X) = \frac{\Gamma(B \rightarrow X \tau \bar{\nu})}{\Gamma(B \rightarrow X \ell \bar{\nu})}$$

$X = D$ or D^*

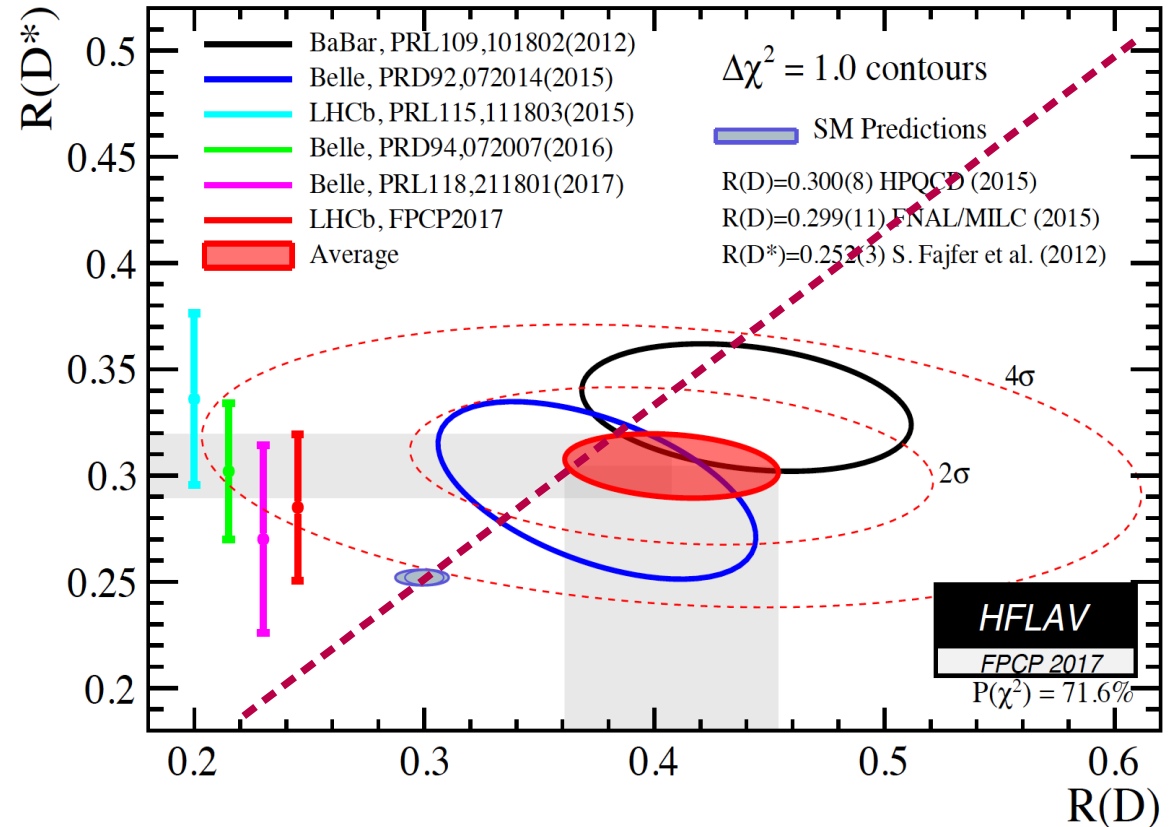
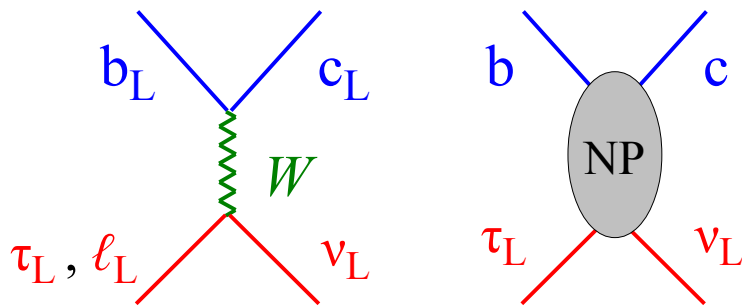

- **SM** prediction quite **solid**: hadronic uncertainties cancel (*to large extent*) in the ratio and deviations from 1 in $R(X)$ expected only from phase-space differences
- Consistent results by 3 different expts. → **3.6–3.9 σ** excess over SM ($D + D^*$)
- The two channels are well consistent with a **universal enhancement** ($\sim 30\%$) of the SM $b_L \rightarrow c_L \tau_L \nu_L$ amplitude

► Introduction [*the recent hopes...* (II) $b \rightarrow s \ell\ell$]

Various (non-LFU) anomalies, from angular distributions and BR's.

Most notably: **theoretically clean** deviations from the SM in LFU μ/e ratios:

$$R_H = \frac{\int d\Gamma(B \rightarrow H \mu\mu)}{\int d\Gamma(B \rightarrow H ee)}$$

$$R_K [1-6 \text{ GeV}^2] = 0.75 \pm 0.09$$

LHCb '14 (vs. 1.00 ± 0.01 SM)

Overall significance $\sim 3.8\sigma$
(LFU ratios only)



All effects (LFU + non-LFU) well described
by NP of short-distance origin only in $b \rightarrow s \mu\mu$
and (& not in ee)

Descotes-Genon, Matias, Virto '13, '15; Capdevila *et al.* '17;
D'Amico *et al.* '17; Altmannshofer & Straub '13, '15, Ciuchini
et al. '17; Hurth *et al.* '16, '17, Many others...

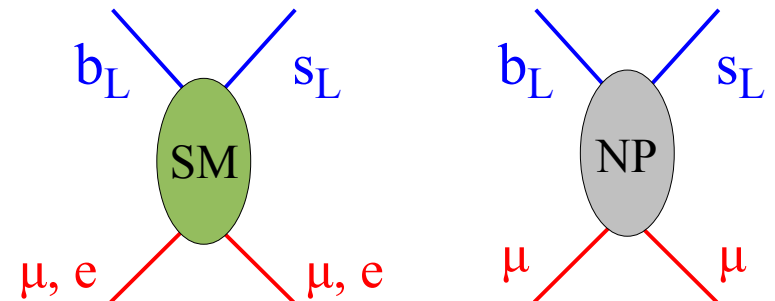
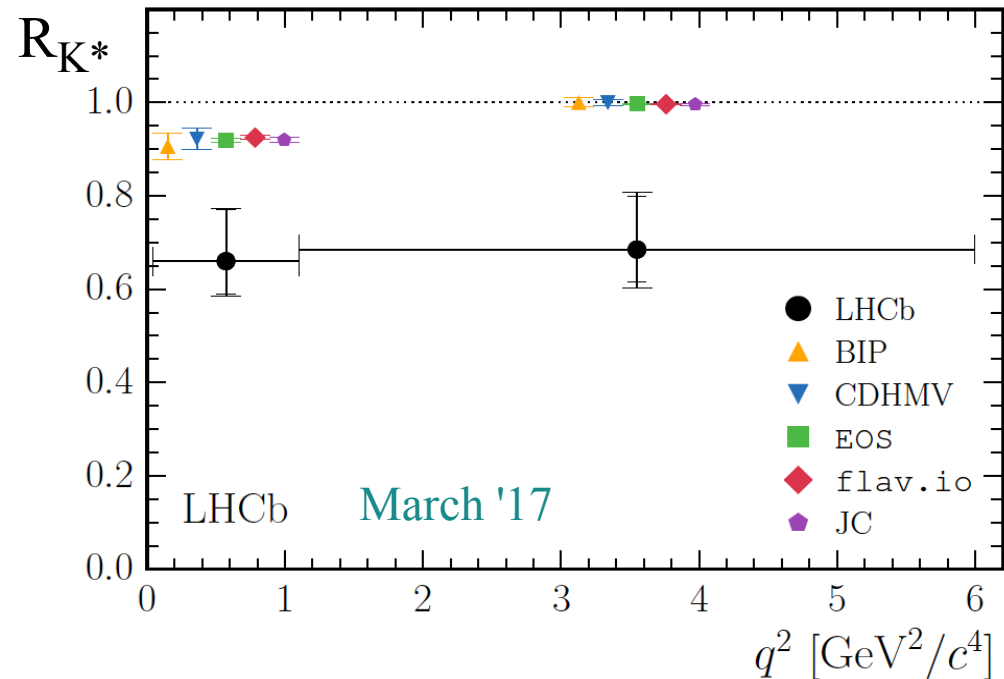

► Introduction [*more about LFU violations*]

Recent data provide “convincing” indications of a *non-universal* behavior among different lepton species in b (3rd gen.) $\rightarrow c,s$ (2nd) semi-leptonic processes:

- $b \rightarrow c$ charged currents: τ vs. light leptons (μ, e)
- $b \rightarrow s$ neutral currents: μ vs. e

IF taken together... this is probably the largest “coherent” set of NP effects in present data...

The “new” flavor puzzle...

What is particularly interesting, is that these anomalies are challenging an assumption (**L**epton **F**lavor **U**niversality), that we gave for granted for many years (*without many good theoretical reasons...*)



Interesting new avenue in BSM constructions
(with implications beyond flavor physics)

► Introduction [*more about LFU violations*]

Suppose we could test matter only with long wave-length photons...

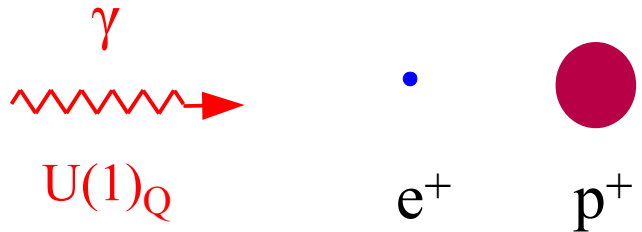

We would conclude that these two particles are “identical copies” but for their mass ...

► Introduction [*more about LFU violations*]

Suppose we could test matter only with long wave-length photons...

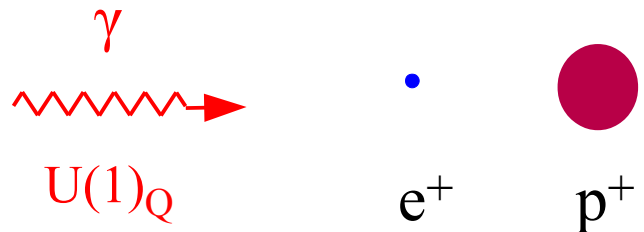

We would conclude that these two particles are “identical copies” but for their mass ...

That's exactly the same (misleading) argument we use to infer LFU...

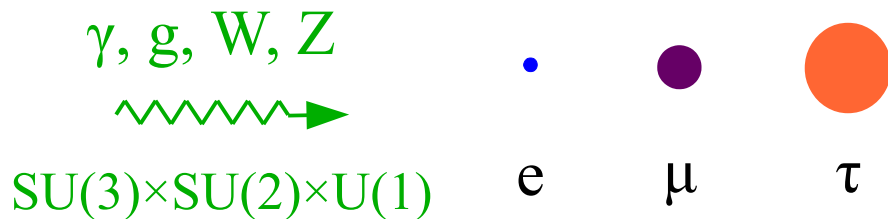

These three (families) of particles seems to be “identical copies” but for their mass ...

The SM quantum numbers of the three families could be an “accidental” low-energy property: the different families may well have a very different behavior at high energies, as signaled by their different mass

► Introduction [*more about LFU violations*]

So far, the vast majority of BSM model-building attempts

- Concentrate only on the Higgs hierarchy problem
- Postpone (ignore) the flavor problem, implicitly assuming the 3 families are “identical” copies (but for Yukawa-type interactions)

“Common lore” (I)

“Common lore” (II)

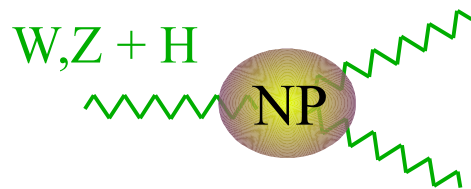

large (*more interesting...*)

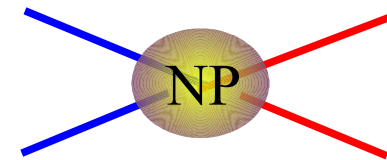

small (*less interesting...*)

► Introduction [*more about LFU violations*]

So far, the vast majority of BSM model-building attempts

- Concentrate only on the Higgs hierarchy problem
- Postpone (ignore) the flavor problem, implicitly assuming the 3 families are “identical” copies (but for Yukawa-type interactions)

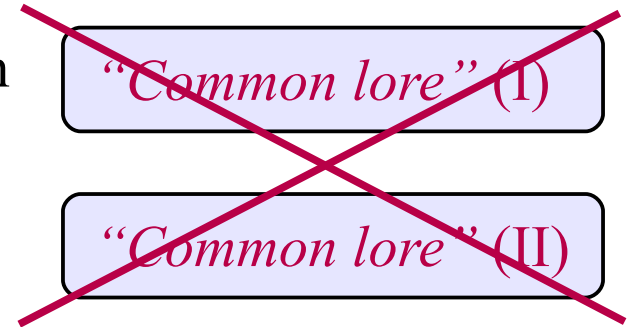

The recent flavor anomalies seem to suggest a new avenue in BSM approaches:

- We should not ignore the flavor problem [\rightarrow *new (non-Yukawa) interactions at the TeV scale distinguishing the different families*]
- A (very) different behavior of the 3 families (with special role for 3rd gen.) *may be the key to solve/understand also the gauge hierarchy problem*

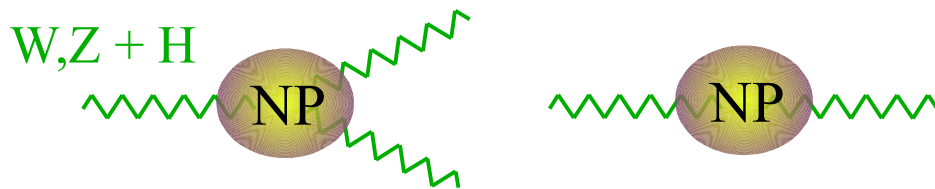

~~large (more interesting...)~~
small (less interesting...)

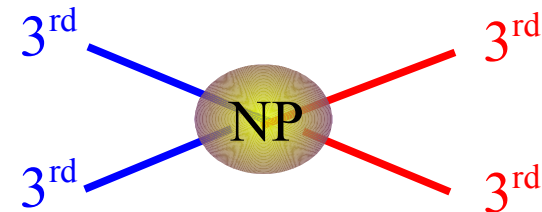

~~small (less interesting...)~~
large (more interesting...)

Bottom-up approaches to describe the anomalies
[*from EFT to simplified models*]



► EFT-type considerations

- Anomalies are seen only in semi-leptonic (quark \times lepton) operators
- Data largely favor non-vanishing left-handed current-current operators [*the Fermi-like $SU(2)_L$ triplet contributes to both charged & neutral curr.*], although other contributions are also possible

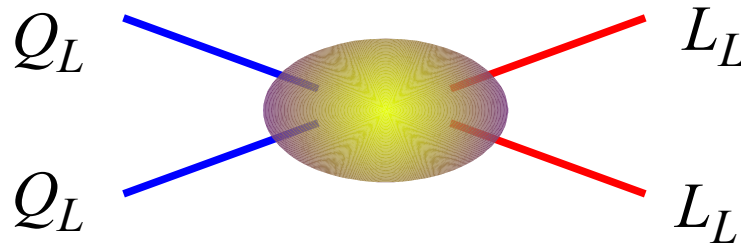

Bhattacharya *et al.* '14
Alonso, Grinstein, Camalich '15
Greljo, GI, Marzocca '15
(+many others...)

► EFT-type considerations

- Anomalies are seen only in semi-leptonic (**quark**×**lepton**) operators
- Data largely favor non-vanishing **left-handed** current-current operators [*the Fermi-like $SU(2)_L$ triplet contributes to both charged & neutral curr.*], although other contributions are also possible

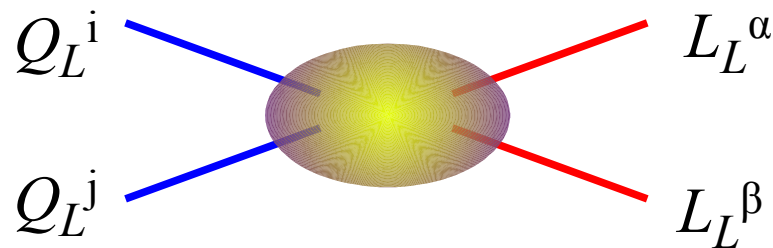

Bhattacharya *et al.* '14
Alonso, Grinstein, Camalich '15
Greljo, GI, Marzocca '15
(+many others...)

- Large coupling (competing with SM tree-level) in **bc** → $l_3 \nu_3$
- Small non-vanishing coupling (competing with SM FCNC) in **bs** → $l_2 l_2$



$$\Lambda_{ij\alpha\beta} = (\delta_{i3} \times \delta_{3j}) \times (\delta_{\alpha 3} \times \delta_{3\beta}) + \text{small terms for 2nd (& 1st) generations}$$



Link to pattern of the Yukawa couplings !

► EFT-type considerations

- Anomalies are seen only in semi-leptonic (**quark**×**lepton**) operators
- Data largely favor non-vanishing **left-handed** current-current operators [*the Fermi-like $SU(2)_L$ triplet contributes to both charged & neutral curr.*], although other contributions are also possible

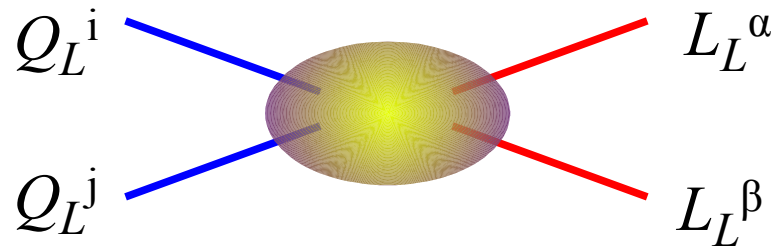

Long list of constraints [FCNCs + semi-leptonic b decays + π , K, τ decays + EWPO]

E.g:

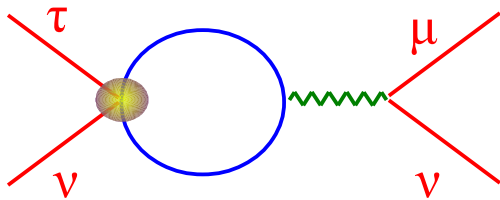

Feruglio, Paradisi, Pattori '16

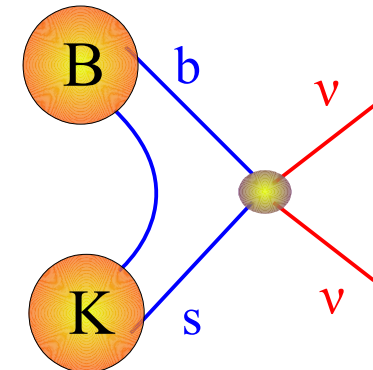
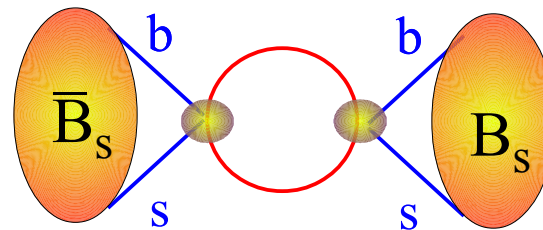

Calibbi, Crivellin, Ota, '15
(+many others...)

+ many more...

► EFT-type considerations [The $U(2)^n$ flavor symmetry]

A good fit to all data + **natural link with the origin of the Yukawa couplings**, is obtained building the EFT on the hypothesis of an approximate $U(2)$ -type chiral flavor symmetry

E.g. up-sector: $U(2)_q \times U(2)_u$

$$Y_U = y_t \begin{bmatrix} 0 & 0 & 0 \\ 0 & 0 & 0 \\ 0 & 0 & 1 \end{bmatrix} \begin{matrix} \leftarrow U(2)_q \\ \\ \uparrow U(2)_u \end{matrix} \quad \begin{matrix} \text{unbroken} \\ \text{symmetry} \end{matrix}$$

$$\rightarrow \begin{bmatrix} \Delta & V \\ \hline & 1 \end{bmatrix} \equiv \begin{bmatrix} \cdot & \bullet \\ \cdot & \blacksquare \\ \hline & \blacksquare \end{bmatrix} \quad \begin{matrix} \text{after symmetry} \\ \text{symmetry} \end{matrix}$$

Barbieri, G.I., Jones-Perez, Lodone, Straub, '11

Main idea: the same symmetry-breaking pattern control the mixing $3^{\text{rd}} \rightarrow 1^{\text{st}}, 2^{\text{nd}}$ gen. for the NP responsible for the anomalies

$$|V| \approx |V_{ts}| = 0.04$$

$$|\Delta| \approx y_c = 0.006$$

N.B.: this symmetry & symmetry-breaking pattern was proposed well-before the anomalies appeared [*it is not ambulance chasing...!*]

► EFT-type considerations [“The Zurich's guide”]

A good fit to all data + **natural link with the origin of the Yukawa couplings**,
is obtained building the EFT on the hypothesis of an approximate
U(2)-type chiral flavor symmetry

+

Assumption of NP in left-handed semi-leptonic operators only
[*at the high-scale*]

Buttazzo, Greljo, GI, Marzocca, '17

“The Zürich's Guide”



$$\mathcal{L}_{\text{eff}} = \mathcal{L}_{\text{SM}} - \frac{1}{v^2} \lambda_{ij}^q \lambda_{\alpha\beta}^\ell \left[\underline{C_T} (\bar{Q}_L^i \gamma_\mu \sigma^a Q_L^j) (\bar{L}_L^\alpha \gamma^\mu \sigma^a L_L^\beta) + \underline{C_S} (\bar{Q}_L^i \gamma_\mu Q_L^j) (\bar{L}_L^\alpha \gamma^\mu L_L^\beta) \right]$$

four free
parameters...

$$\left[\begin{array}{l} C_T, C_S \\ \lambda_{bs} = O(V_{cb}) \\ \lambda_{\mu\mu} = O(|V_{\tau\mu}|^2) \end{array} \right]$$

...and a long list of constraints
[FCNC and CC semi-leptonic processes,
tau decays, EWPO]

► EFT-type considerations [“The Zurich's guide”]

Excellent fit to both anomalies, passing all existing constraints with **no fine tuning**

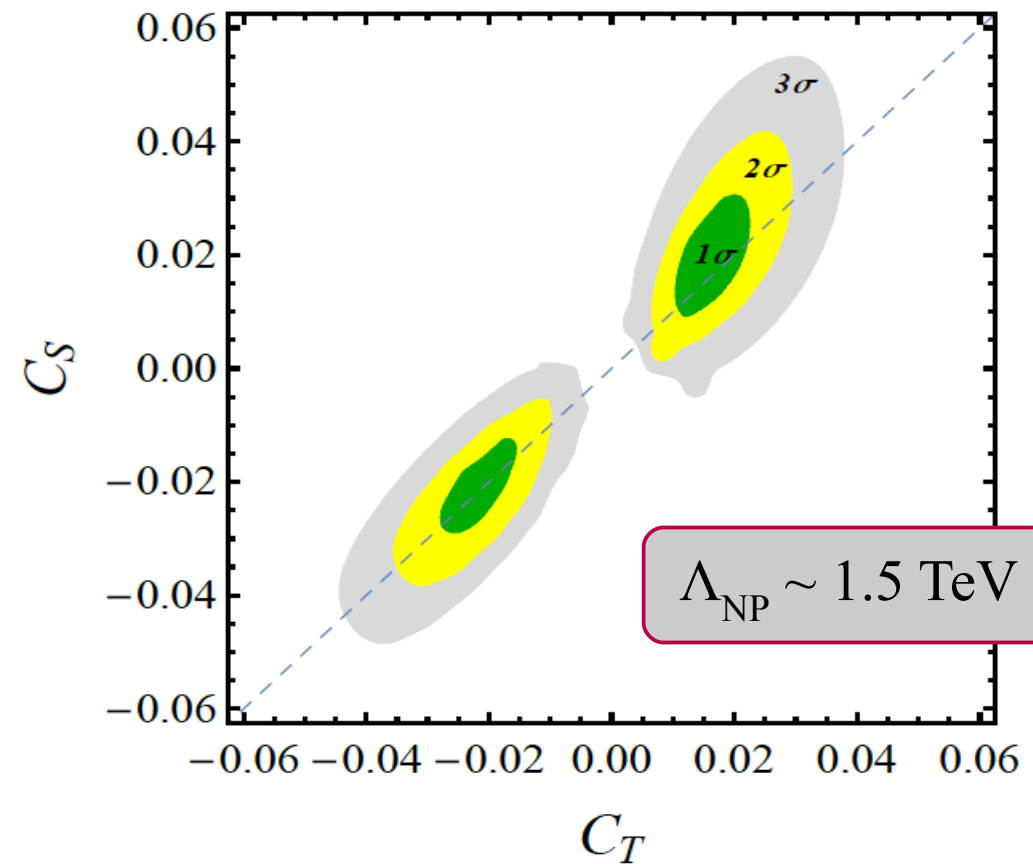
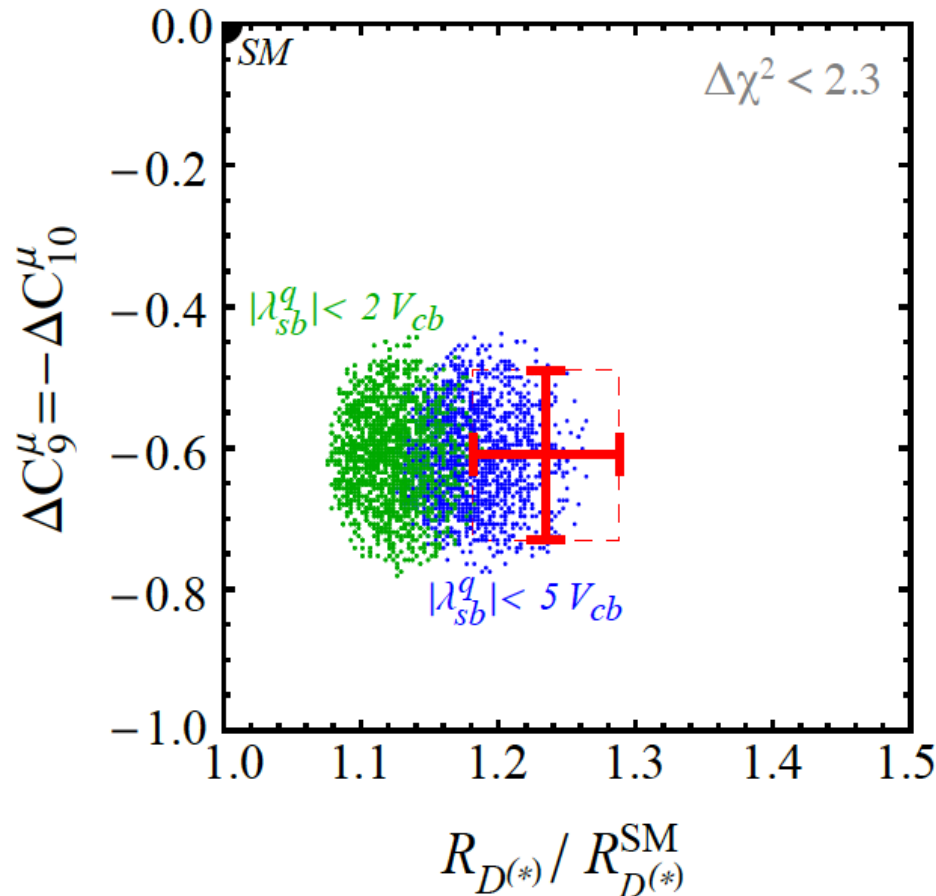

- The virtue of this EFT approach is the demonstration that it is possible to find a “combined” (*motivated*) explanation of the two sets of anomalies.
- The EFT solution is not unique [e.g. sub-leading RH currents can be added], but large variations are possible only if the R_D anom. goes away completely

► Simplified dynamical models [“The Return of the LeptoQuark”...]

If we ask which tree-level mediators can generate the effective operators required by the EFT fit, we have not many possibilities...

Three main options
(for the combined explanation):

	SU(2) _L	
	singlet	triplet
Vector LQ:	U_1	U_3
Scalar LQ:	S_1	S_3
Colorless vector:	B'	W'

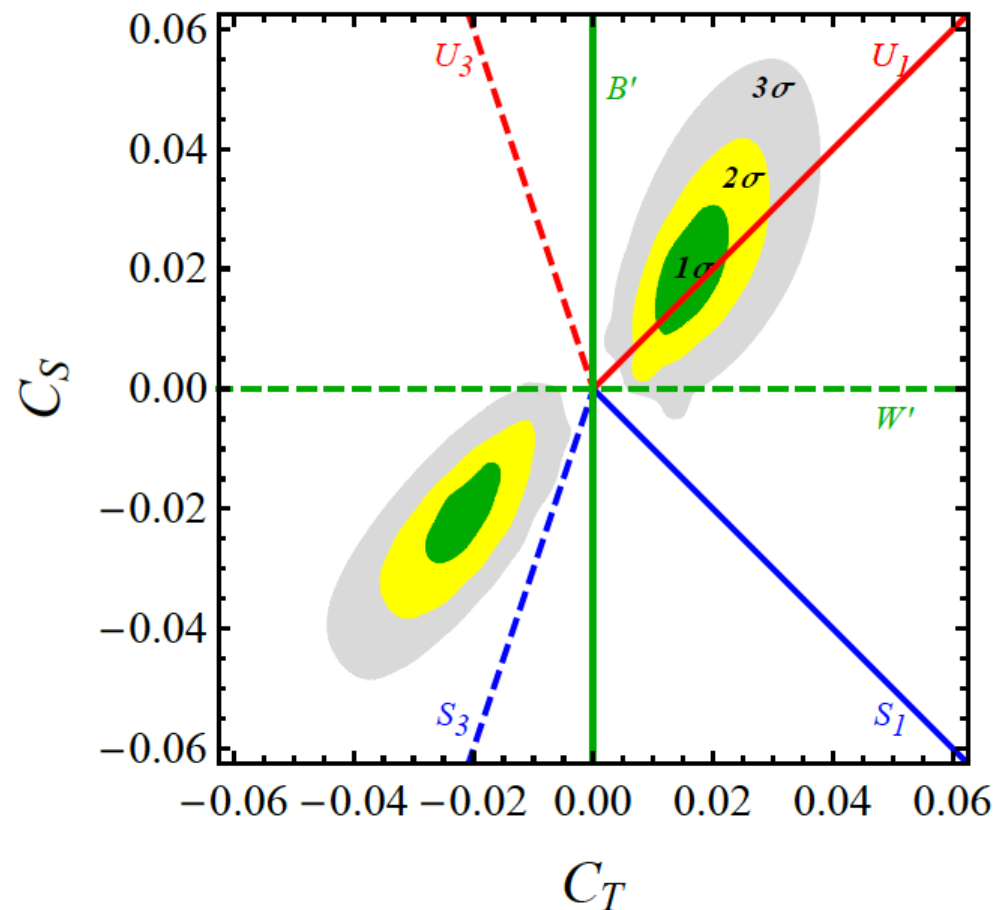

The U_1 option fits quite nicely... but of course models with more than one mediators are possible

► Simplified dynamical models [“The Return of the LeptoQuark”...]

If we ask which tree-level mediators can generate the effective operators required by the EFT fit, we have not many possibilities...

Three main options
(for the combined explanation):

	SU(2) _L	
	singlet	triplet
Vector LQ:	U_1	U_3
Scalar LQ:	S_1	S_3
Colorless vector:	B'	W'

Similarly, 3rd gen. LQ are in very good shape also as far as direct searches are concerned (contrary to Z' ...):

LQ (both scalar and vectors) have an additional clear advantage concerning constraints from non-semileptonic processes:

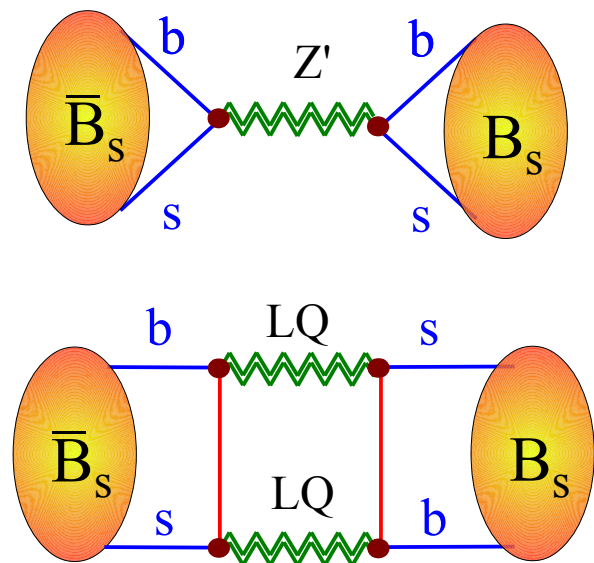

Speculations on UV completions



► Speculations on UV completions

Two main approaches

Non-perturbative
TeV-scale dynamics

[*non-renormalizable models*]

- Scalar LQ as PNG
 - Gripaios, '10
 - Gripaios, Nardecchia, Renner, '14
 - Marzocca '18
- Vector LQ (or W', Z') as technifermion resonances
 - Barbieri *et al.* '15, Buttazzo *et al.* '16
 - Barbieri, Murphy, Senia, '17
 - Blanke, Crivellin, '17
- W', Z' as Kaluza-Klein excitations
[*e.g. from warped extra dim.*]
 - Megias, Quiros, Salas '17
 - Megias, Panico, Pujolas, Quiros '17

Perturbative

TeV-scale dynamics

[*renormalizable models*]

- Renormalizable models with scalar mediators [*LQ, but also RPV-SUSY*]
 - Hiller & Schmaltz, '14
 - Becirevic *et al.* '16, Fajfer *et al.* '15-'17
 - Dorsner *et al.* '17
 - Crivellin, Muller, Ota '17
 - Altmannshofer, Dev, Soni, '17
 - + ...
- Gauge models
 - Cline, Camalich '17
 - Calibbi, Crivellin, Li, '17
 - Assad, Fornal, Grinstein, '17
 - Di Luzio, Greljo, Nardecchia, '17
 - Bordone, Cornella, Fuentes-Martin, GI, '17
 - + ...

► Speculations on UV completions

In the following I will now concentrate on one (class of) option(s) that I find particularly interesting.

Starting observation: the Pati-Salam model predicts a massive vector LQ with the correct quantum numbers to fit the anomalies (*best single mediator*):

Pati-Salam group: $SU(4) \times SU(2)_L \times SU(2)_R$

$$\text{Fermions in } SU(4): \quad \begin{bmatrix} Q_L^\alpha \\ Q_L^\beta \\ Q_L^\gamma \\ L_L \end{bmatrix} \quad \begin{bmatrix} Q_R^\alpha \\ Q_R^\beta \\ Q_R^\gamma \\ L_R \end{bmatrix} \quad \text{LQ } [U_1] \text{ from } SU(4) \rightarrow SU(3)_c$$

The problem of the “original PS model” are the strong bounds on the LQ couplings to 1st & 2nd generations [e.g. $M > 200 \text{ TeV}$ from $K_L \rightarrow \mu e$].

Interesting recent attempts to solve this problem adding extra fermions and/or modifying the gauge group [Calibbi, Crivellin, Li, '17; Di Luzio, Greljo, Nardecchia, '17]

► The PS³ model

$$[\text{PS}]^3 = [\text{SU}(4) \times \text{SU}(2)_L \times \text{SU}(2)_R]^3$$

Bordone, Cornella,
Fuentes-Martin, GI, '17

Main idea: at high energies the 3 families are charged under 3 independent gauge groups (*gauge bosons carry a flavor index !*)

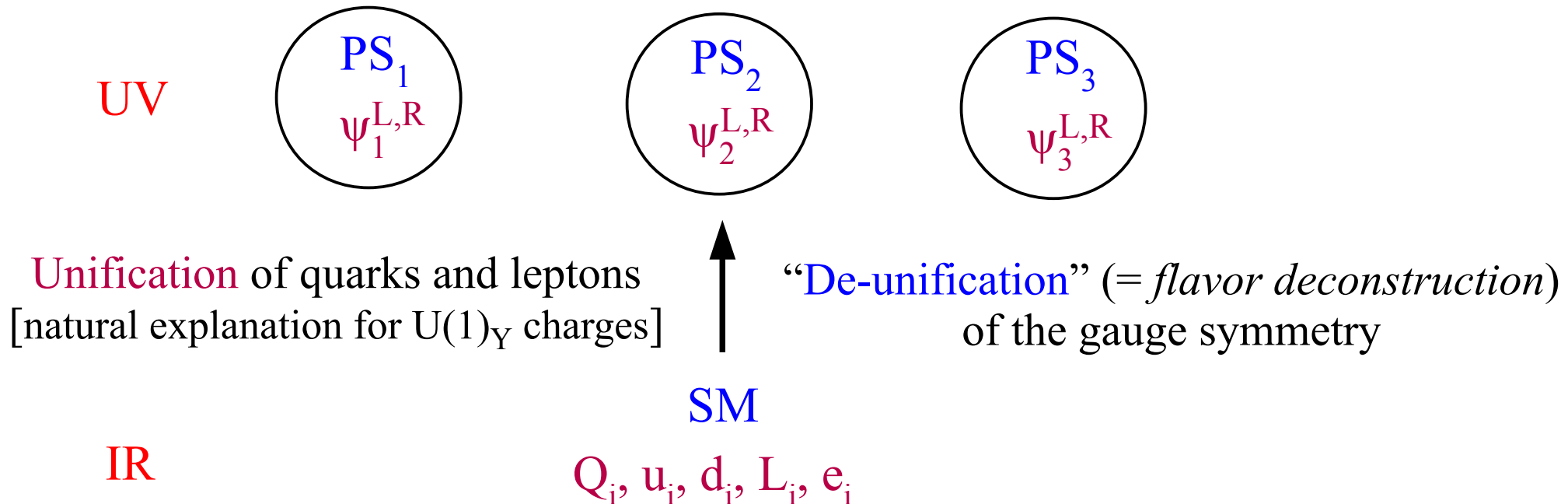

Key advantages:

- Light LQ coupled mainly to 3rd gen.
- Accidental $U(2)^5$ flavor symmetry
- Natural structure of SM Yukawa couplings

► The PS³ model

$$[\text{PS}]^3 = [\text{SU}(4) \times \text{SU}(2)_L \times \text{SU}(2)_R]^3$$

Bordone, Cornella,
Fuentes-Martin, GI, '17

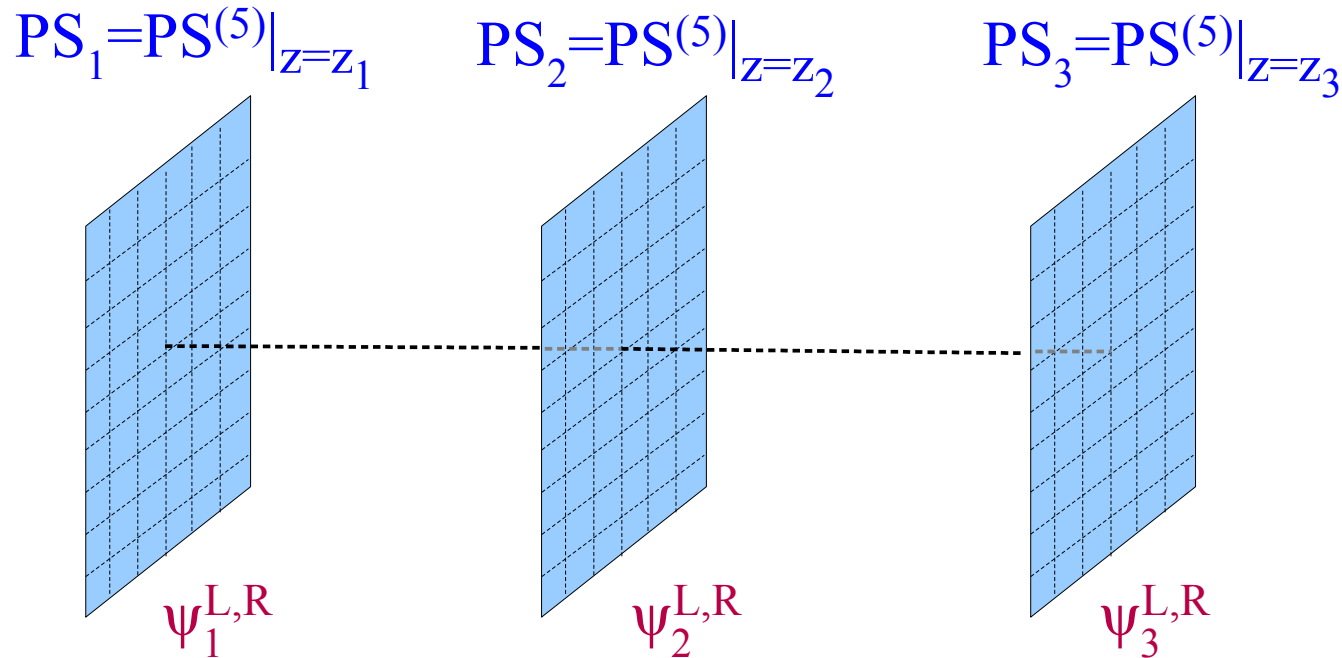

Unification
of quarks and leptons

“De-unification”
(= *flavor deconstruction*)
of the gauge symmetry

This construction can find a “natural” justification in the context of models with extra space-time dimensions

The 4D description is apparently more complex, but it allow us to derive precise low-energy phenomenological signatures (*4D renormalizable gauge model*)

► *The PS³ model*

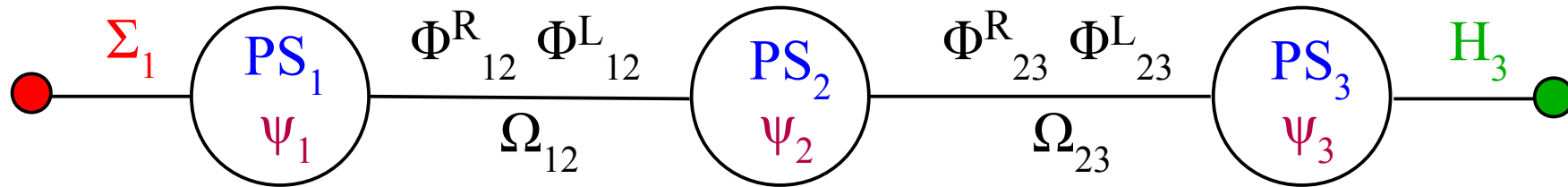

High-scale [$\sim 10^3$ TeV]
 “vertical” breaking [PS \rightarrow SM]

PS₁ [SU(4)₁ × SU(2)^R₁]



SM₁ [SU(3)₁ × U(1)^Y₁]

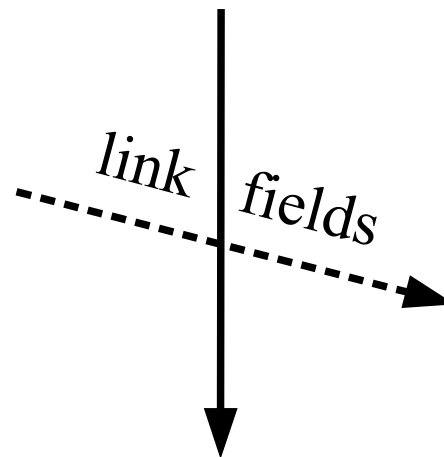

SM (\rightarrow QED)

Low-scale “vertical”
 Breaking [EWSB]

SM₃ [SU(2)^L₁ × U(1)^Y₁]



QED₃ [U(1)^Q₁]

- ★ The breaking to the diagonal SM group occurs via appropriate “link” fields, responsible also for the generation of the hierarchy in the Yukawa couplings.
- ★ The 2-3 breaking gives a TeV-scale LQ [+ Z' & G'] coupled mainly to 3rd gen. [similar to “4321” (Di Luzio et al. '17) but “natural” flavor structure: no ad-hoc mixings]

► The PS³ model

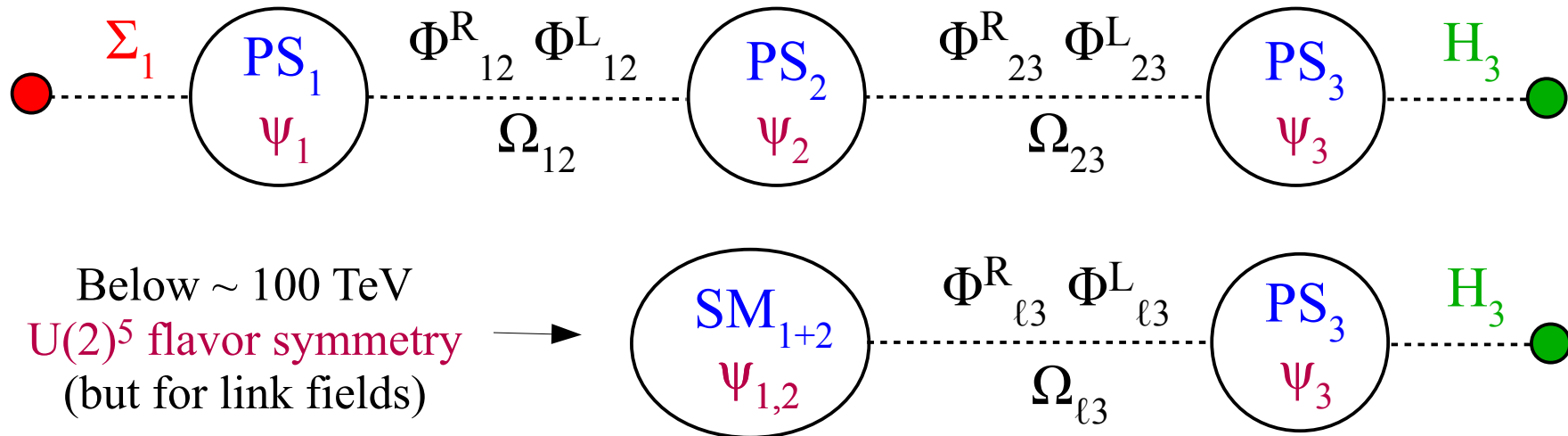

Leading flavor structure:

- Yukawa coupling for 3rd gen. only
- “Light” LQ field (from PS₃) coupled only to 3rd gen.
- $U(2)^5$ symmetry protects flavor-violating effects on light gen.

► *The PS³ model*

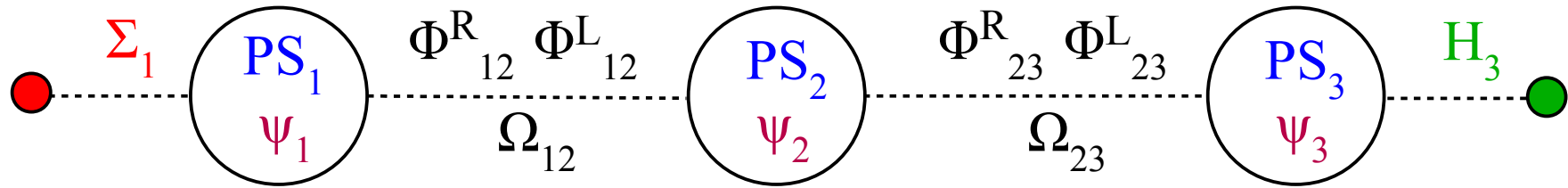

Below ~ 100 TeV
 $U(2)^5$ flavor symmetry
 (but for link fields)

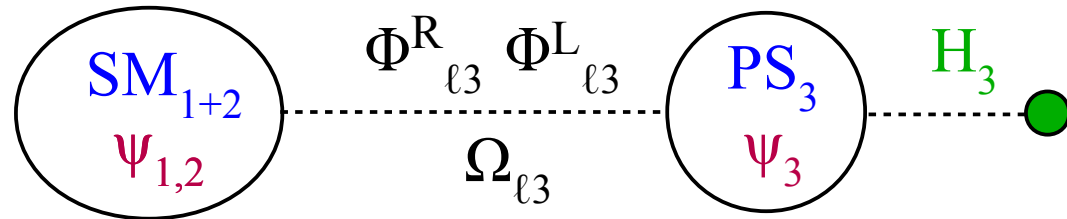

$\rightarrow W'_L + W'_R$ [$\sim 5-10$ TeV]

*Sub-leading Yukawa terms
 from higher dim ops:*

$$Y_U = \begin{bmatrix} \Delta & V \\ \vdots & y_t \end{bmatrix}$$

$$\frac{\langle \Phi_{\ell 3}^R \Phi_{\ell 3}^L \rangle}{(\Lambda_{23})^2} \quad \frac{\langle \Omega_{\ell 3} \rangle}{\Lambda_{23}}$$

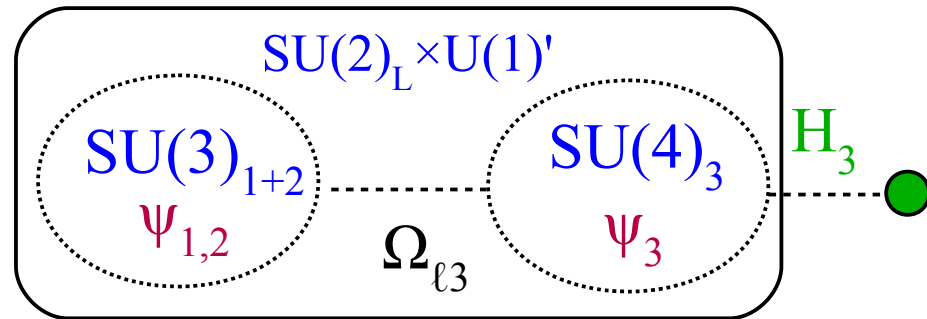

$\rightarrow LQ [U_1] + Z' + G'$ [$\sim 2-3$ TeV]

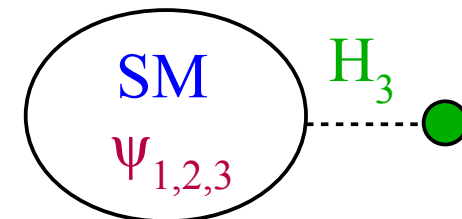

► The PS³ model

Collider phenomenology and flavor anomalies are controlled by the last-but one step in the breaking chain.

Despite the apparent complexity, the construction is highly constrained

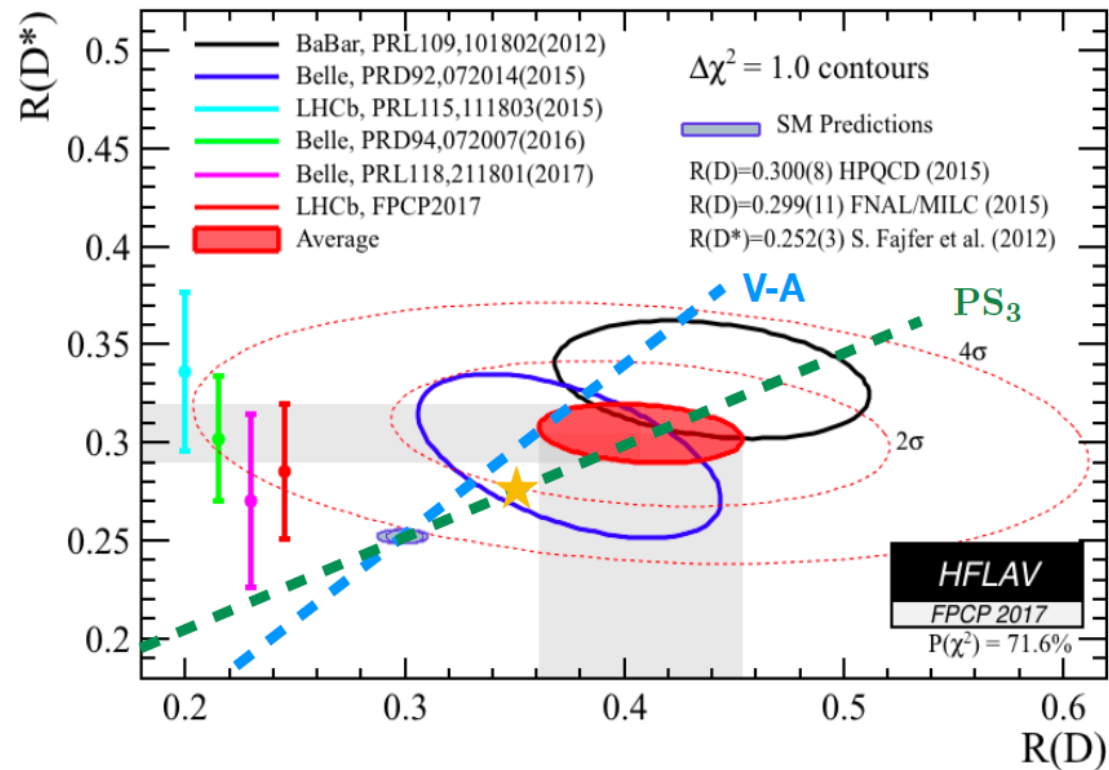
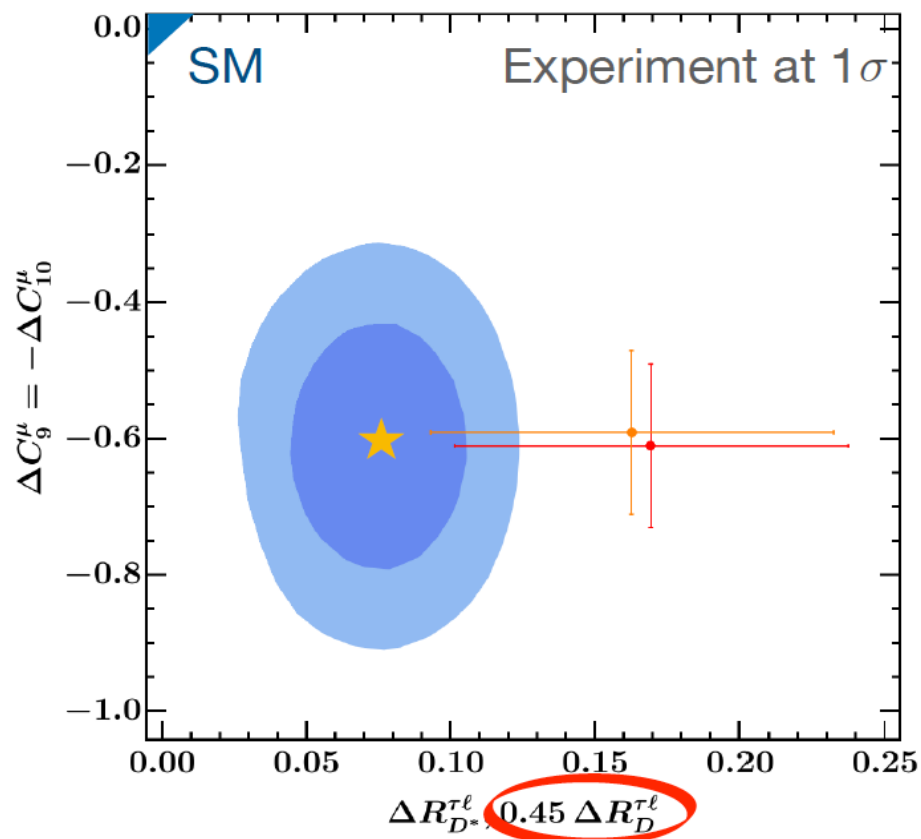

The fit to low-energy data is rather good
(*slightly smaller NP effects in R_D , mainly because of radiative constraints*)

Important difference with respect to all other models:

RH couplings of the LQ

Possible future implications

*“It is very difficult to make predictions,
especially about the future”*

[attributed to Niels Bohr]

► Implications for low-energy flavor physics

If the anomalies are due to NP, we should expect to see several other BSM effects in low-energy observables

Main message: “**super-reach**” flavor program for **LHCb**, but also other flavor physics facilities (**Belle-II**, **Kaons**, **CLFV**)

E.g: Possible large $\tau \rightarrow \mu$
LFV transitions

Glashow, Guadagnoli, Lane '15

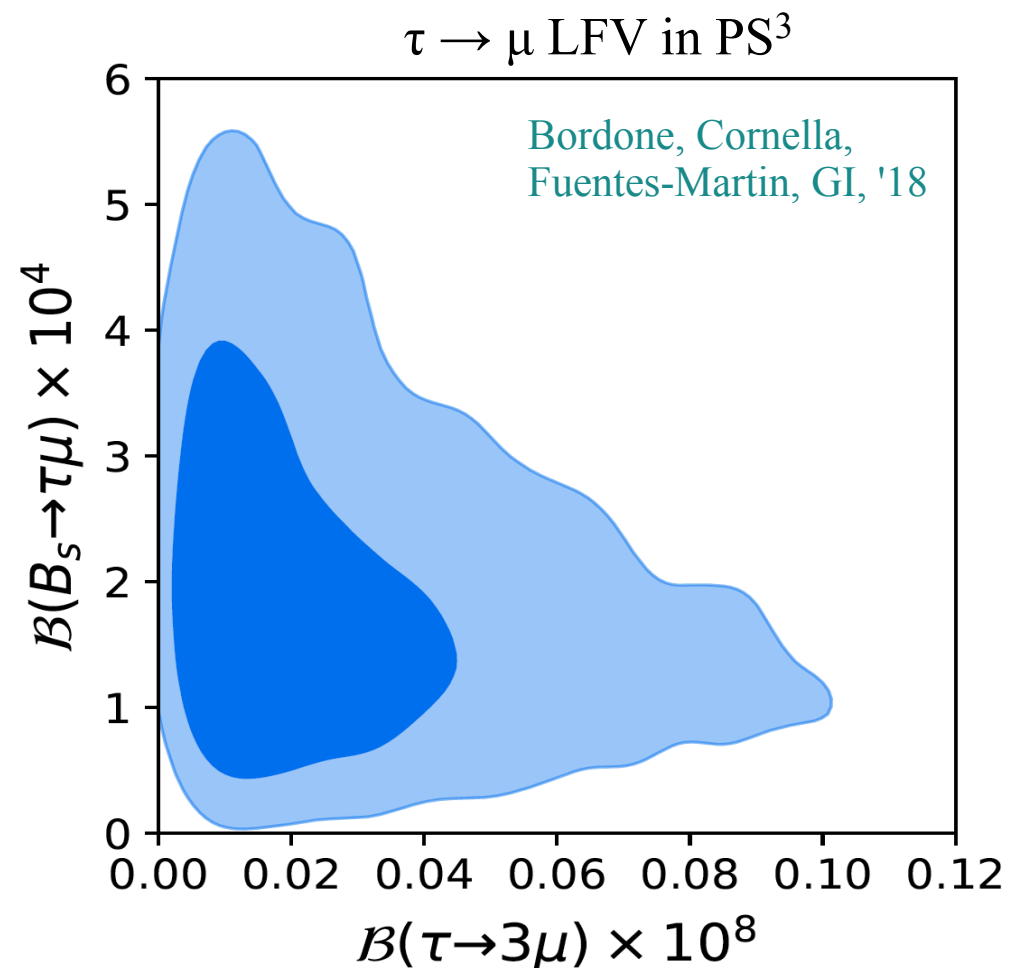

► Implications for high- p_T physics

Some general considerations:

Independently of the details of the UV models, the anomalies point to NP in the ball-park of direct searches @ LHC

- ★ $R_{D^{(*)}}$ necessarily points to a low NP scale: $M \sim g \times (1.0 \text{ TeV})$
- ★ $R_{K^{(*)}}$ also points to a low NP scale, but for (unnaturally) large flavor-violating couplings

This NP could have escaped detection so far only under specific circumstances (*that are fulfilled by the proposed UV completions*):

- Coupled mainly to 3rd generation (→ *no large coupl. to proton valence quarks*)
- No narrow peaks in dilepton pairs (*including tau pairs*)



Significant room for improvement for the corresponding searches @ HL-LHC
But only HE-LHC would be able to rule out all reasonable models

► Implications for high- p_T physics

Also as far as direct searches are concerned, 3rd gen. LQ are in good shape:

N.B.: The single production might be quite relevant

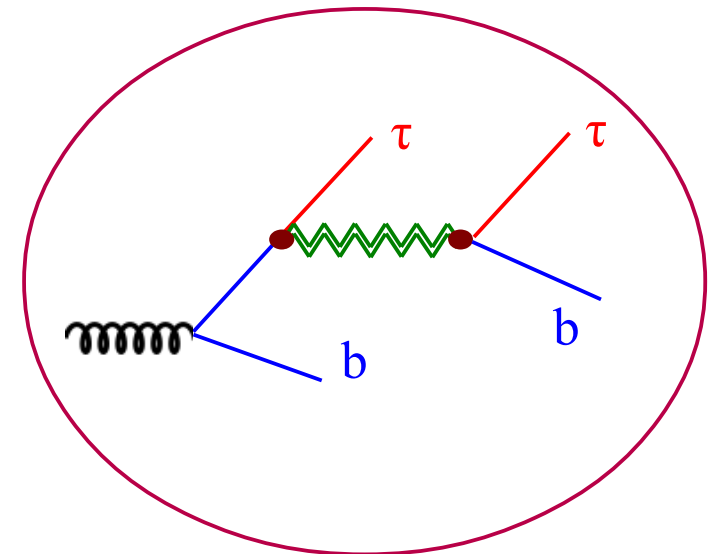
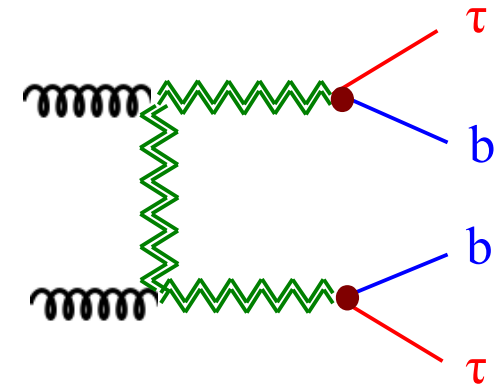
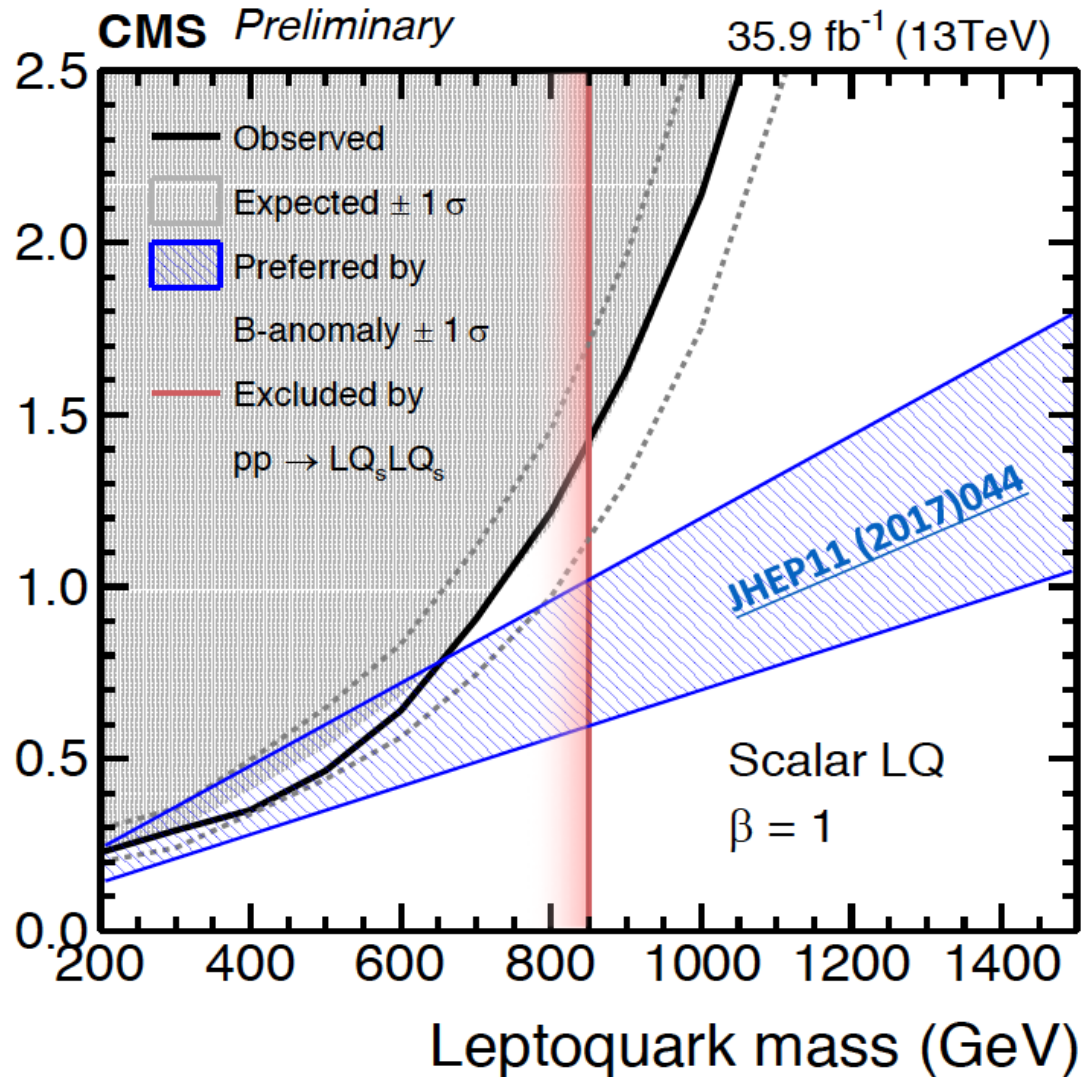

► Implications for high- p_T physics

Additional considerations for direct searches:

- I. The production of all type of mediators occurs predominantly in conjunction with b quarks → b-tag helps

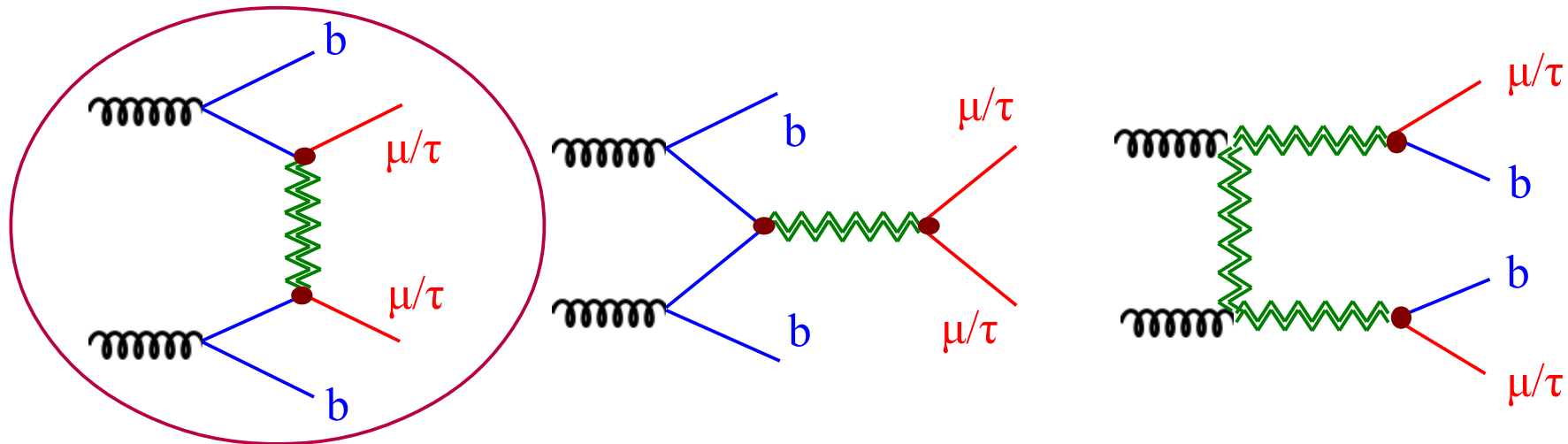

- II. The R_D anomaly unambiguously points out to large $pp \rightarrow \tau\tau$ (independently of the mediator), but narrow peaks in τ disfavored
- III. BR into μ pairs (or $\mu\tau$) always expected but naturally suppressed vs. taus [$O(0.1)$ @ amplitude level for each muon – larger model dependence] except in models addressing only R_K

► Implications for high- p_T physics

Additional considerations for direct searches:

- I. The production of all type of mediators occurs predominantly in conjunction with b quarks → b-tag helps

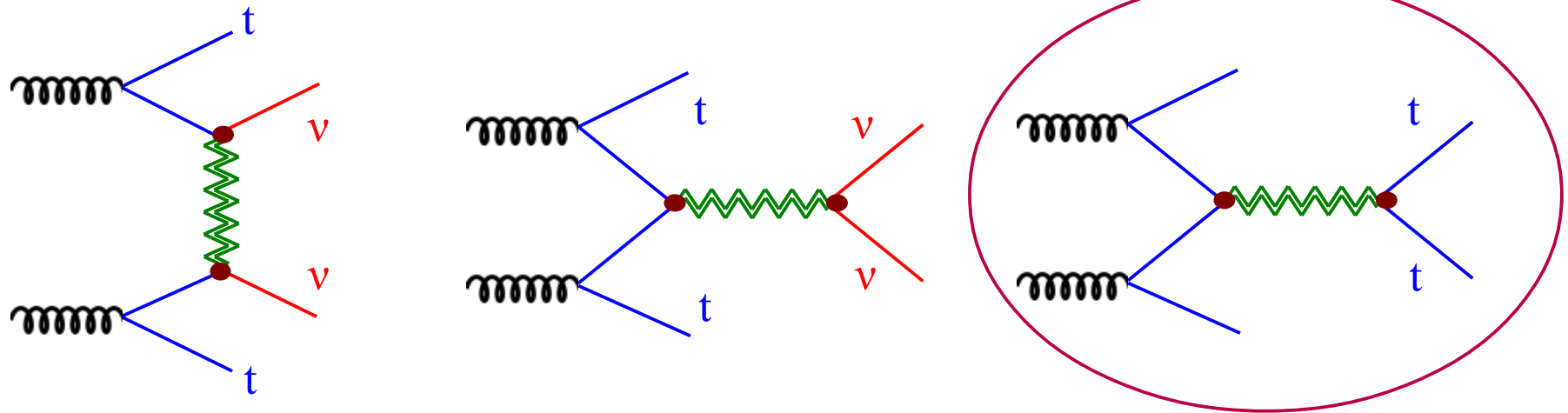

- II. The R_D anomaly unambiguously points out to large $pp \rightarrow \tau\tau$ (independently of the mediator), but narrow peaks in τ disfavored
- III. BR into μ pairs (or $\mu\tau$) always expected but naturally suppressed vs. taus [$O(0.1)$ @ amplitude level for each muon – larger model dependence] except in models addressing only R_K
- VI. Large BRs into top pairs naturally expected in most models, especially when considering also “additional” heavy states

► Implications for high- p_T physics

E.g.: The “Coloron”

In models such as PS^3 or the 4321, the LQ is accompanied by a (non-universal) heavy gluon, coupled mainly to 3rd gen.

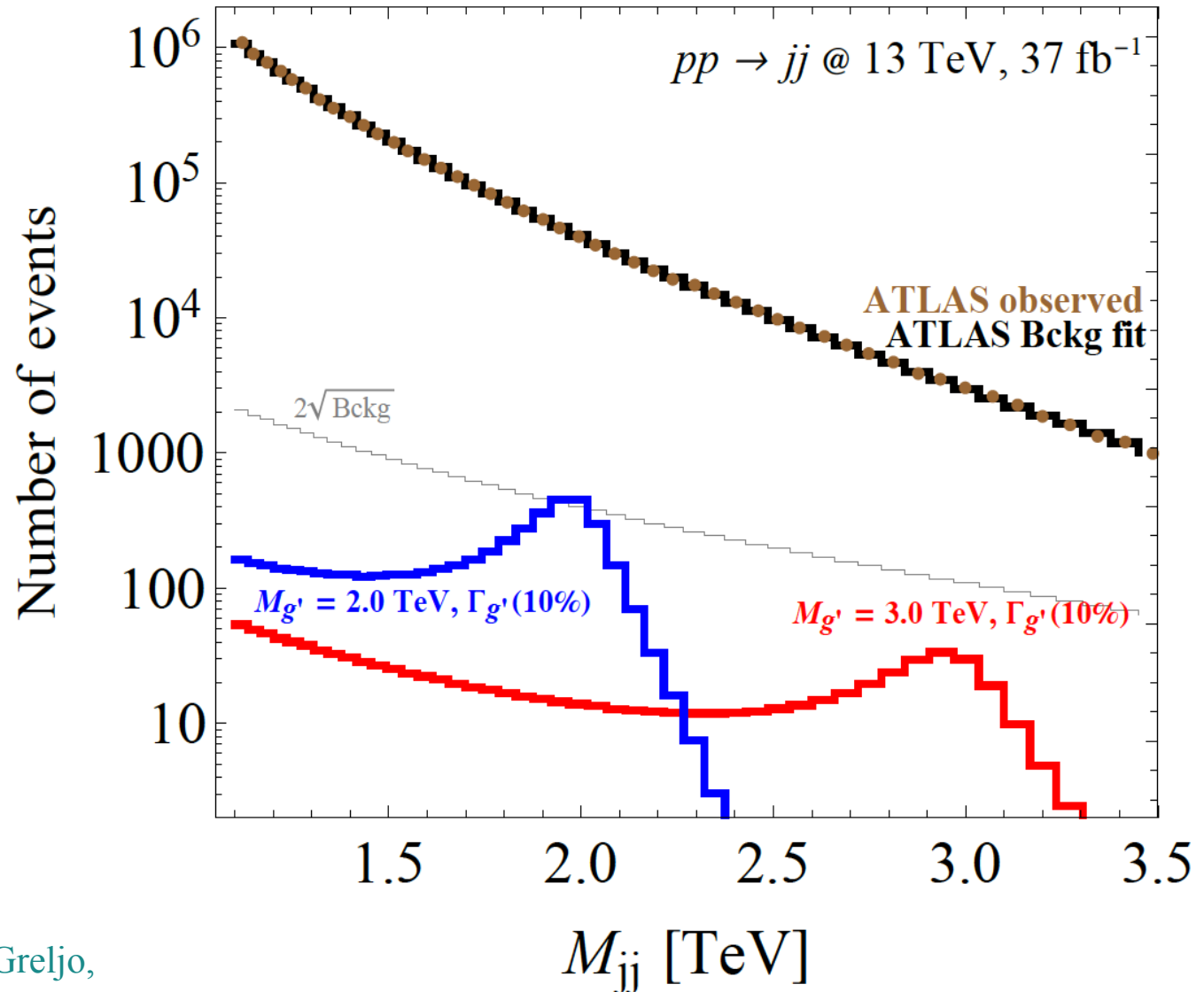

► Implications for high- p_T physics

E.g.: The “Coloron”

In models such as PS^3 or the 4321, the LQ is accompanied by a (non-universal) heavy gluon, coupled mainly to 3rd gen.

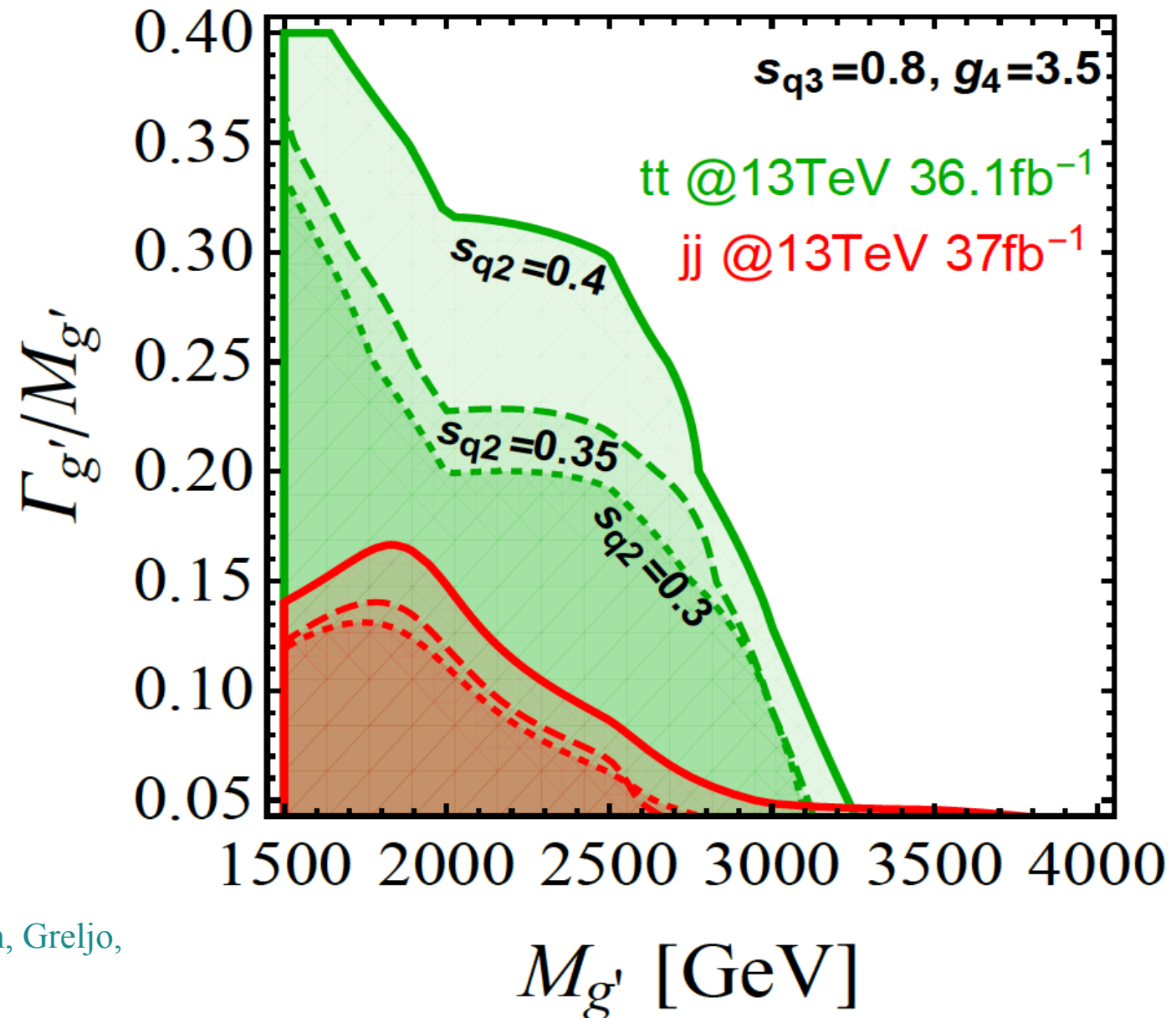

Conclusions

- If these ~~LFU~~ anomalies were confirmed, it would be a fantastic discovery, with far-reaching implications
- If interpreted as NP signals, both set of anomalies are not in contradiction among themselves & with existing low- & high-energy data. Taken together, they point out to NP coupled mainly to 3rd generation, with a flavor structure connected to that appearing in the SM Yukawa couplings
- **Simplified models with LQ states seem to be favored.** However, realistic UV for these models naturally imply a much richer spectrum of states at the TeV scale (*and possibly above...*).
- The PS³ model I have presented is particularly interesting as example of the change of approach in model building that these anomalies could imply. But many points/possible-variations remains to be clarified/explored...



A lot of fun ahead of us...

(both on the exp., the pheno, and model-building point of view)



► $B \rightarrow D^{(*)} \tau \nu$ [Babar, Belle, LHCb]

Test of **L**epton **F**lavor **U**niversality in charged currents
[τ vs. light leptons (μ , e)]:

$$R(X) = \frac{\Gamma(B \rightarrow X \tau \bar{\nu})}{\Gamma(B \rightarrow X \ell \bar{\nu})}$$

$$X = D \text{ or } D^*$$

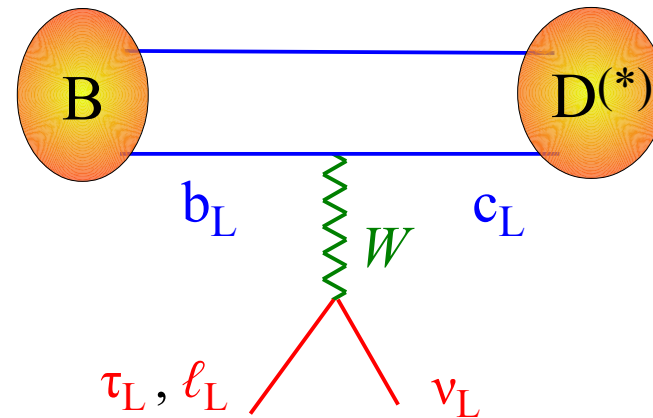

- **SM** prediction quite **solid**: hadronic uncertainties cancel (*to large extent*) in the ratio and deviations from 1 in $R(X)$ expected only from phase-space differences and radiative corr. [de Boer, Kitahara, Nisandzic '18]

► Anomalies in $B \rightarrow K^{(*)} \mu\mu / ee$ [LHCb]

Several groups performed global fits of all the available $b \rightarrow sll$ observables

No consensus on the significance of the non-LFU observables, but full agreement on the main aspects:

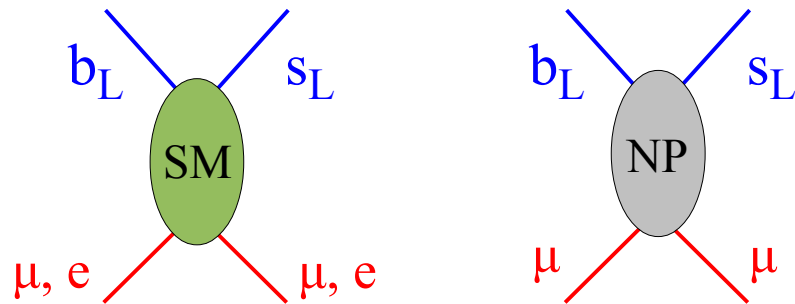

- All effects well described by NP of short-distance origin only in $b \rightarrow s\mu\mu$ and (& not in ee)
- LH structure on the quark side:

$$\mathcal{O}_9 = \frac{e^2}{16\pi^2} (\bar{s}\gamma_\mu P_L b) (\bar{\ell}\gamma^\mu \ell)$$

$$\mathcal{O}_{10} = \frac{e^2}{16\pi^2} (\bar{s}\gamma_\mu P_L b) (\bar{\ell}\gamma^\mu \gamma_5 \ell)$$

Descotes-Genon, Matias, Virto '13, '15
 Capdevila *et al.* '17; D'Amico *et al.* '17
 Altmannshofer & Straub '13, '15
 Ciuchini *et al.* '17; Hurth *et al.* '16, '17
 Many others...

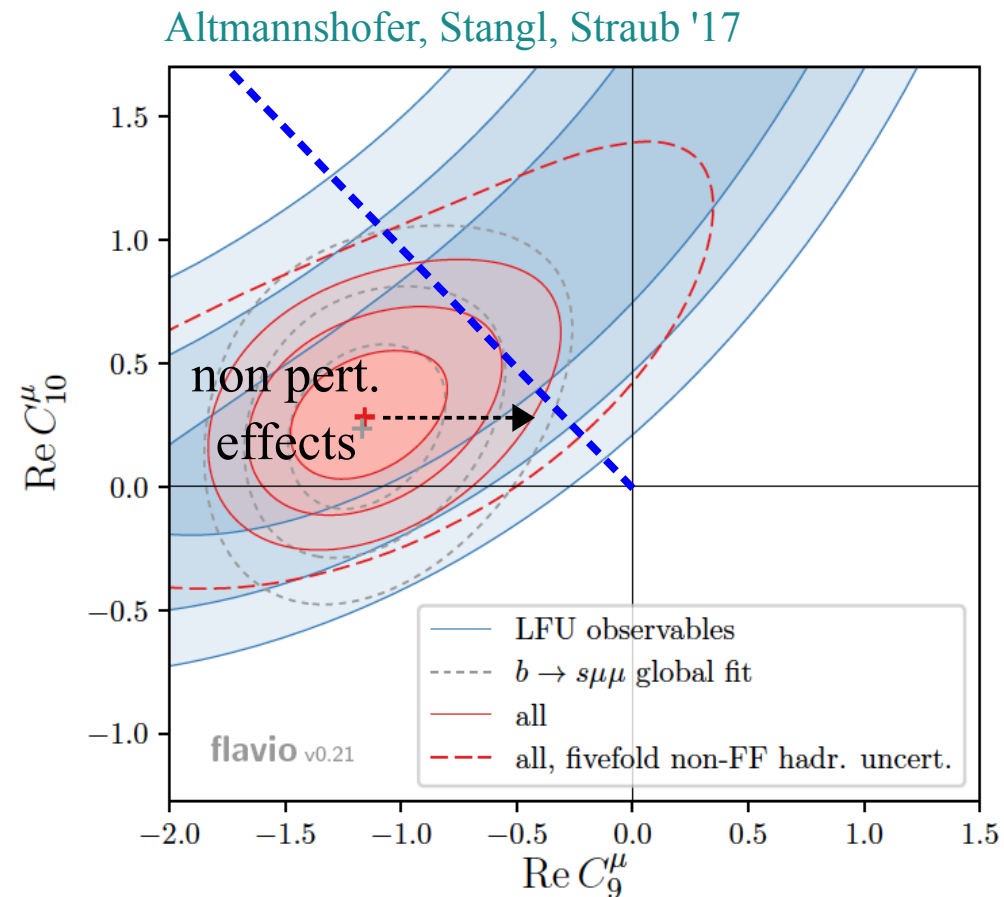

► Anomalies in $B \rightarrow K^{(*)} \mu\mu / ee$ [LHCb]

Technical note: I don't think we should be too worried about the low- q^2 bin...

“dangerous” choice of the bin starting from the di-muon threshold

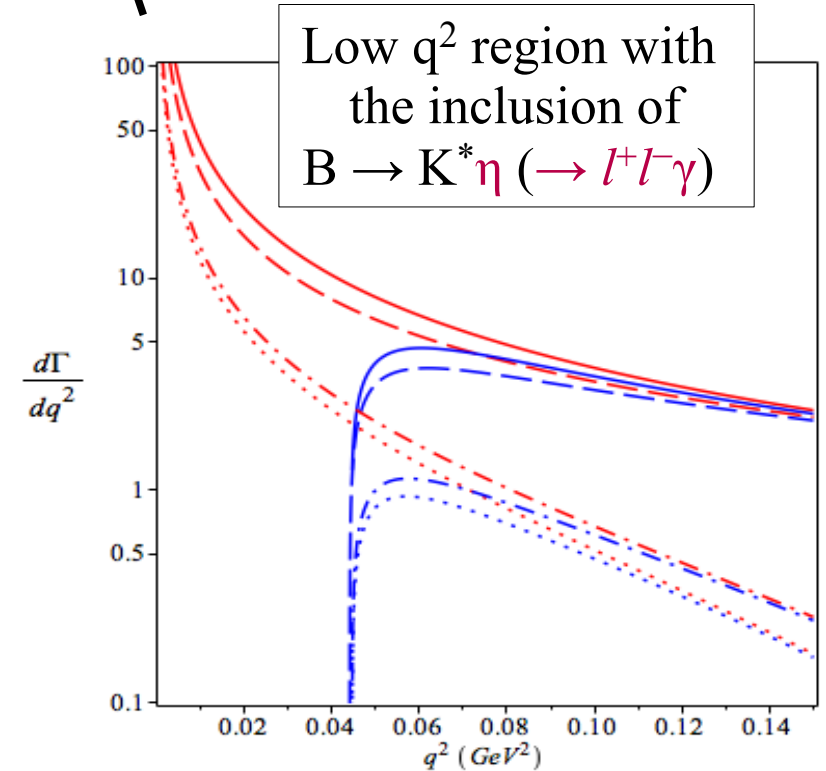
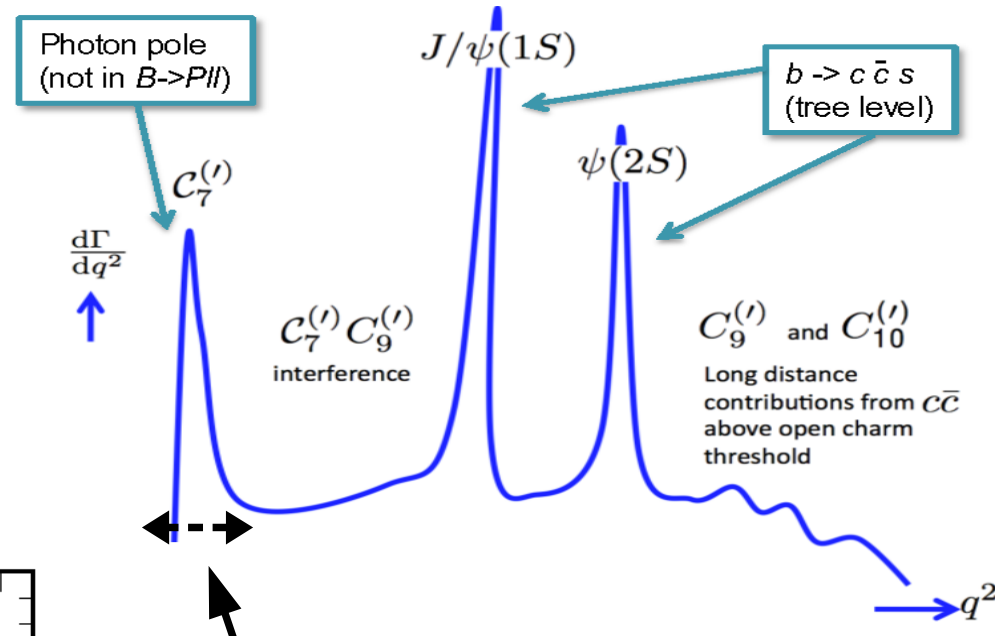
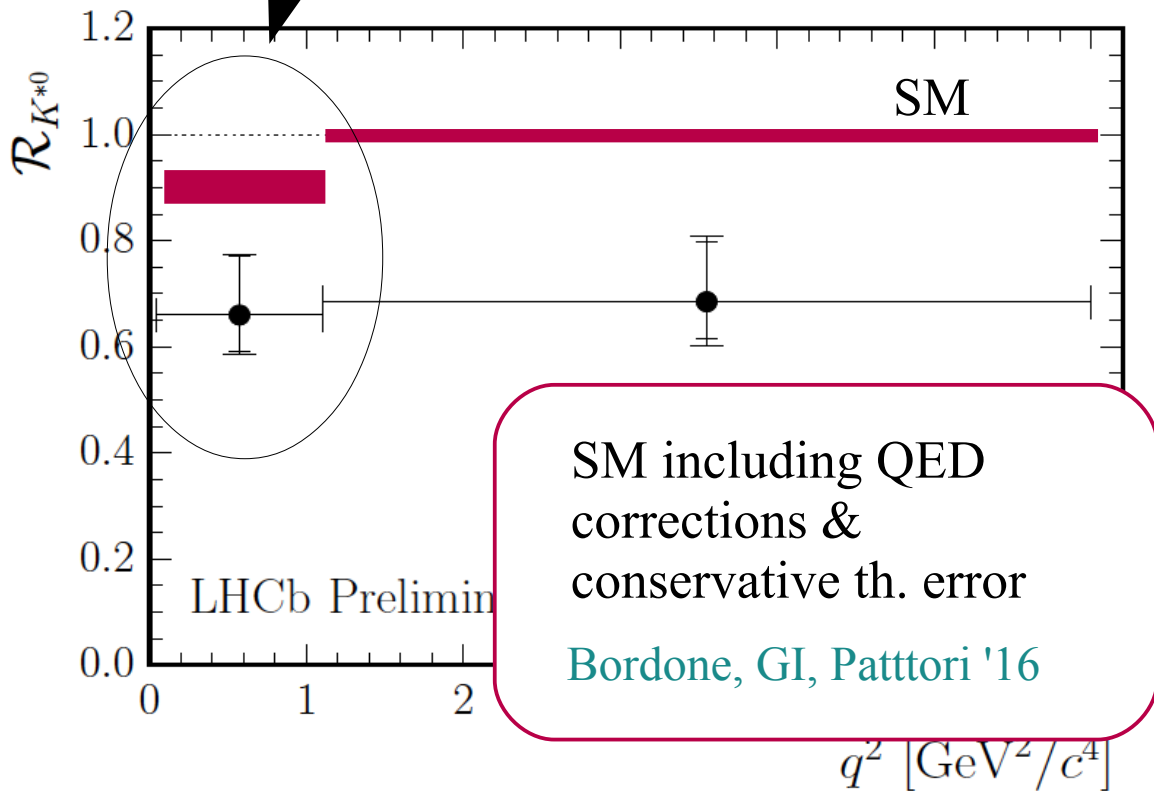

► Anomalies in $B \rightarrow K^{(*)} \mu\mu / ee$ [LHCb]

Pro NP: reduced tension in all the observables with a unique fit of non-standard short-distance Wilson coefficients

Descotes-Genon, Matias, Virto '13, '15
 Capdevila *et al.* '17; D'Amico *et al.* '17
 Altmannshofer & Straub '13, '15
 Ciuchini *et al.* '17; Hurth *et al.* '16, '17
 Many others...

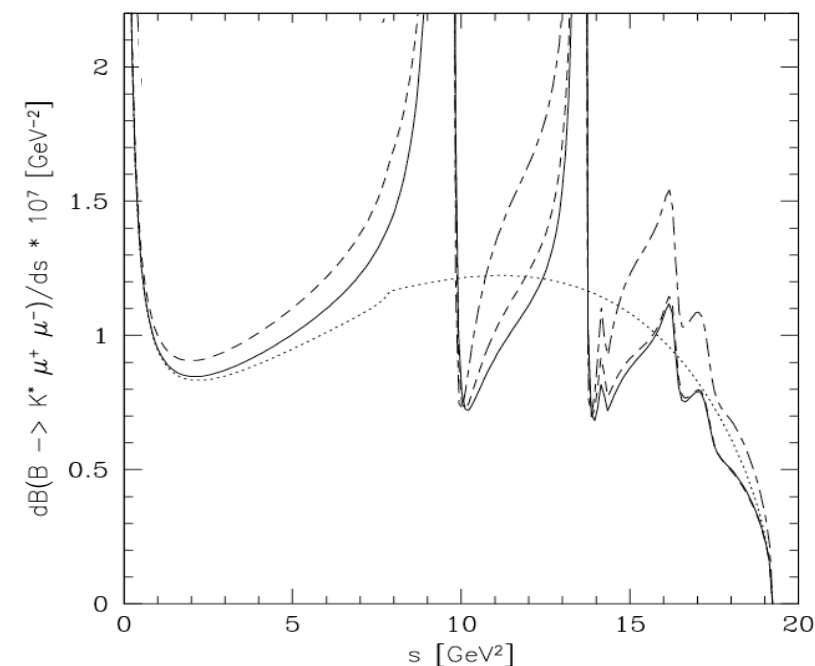
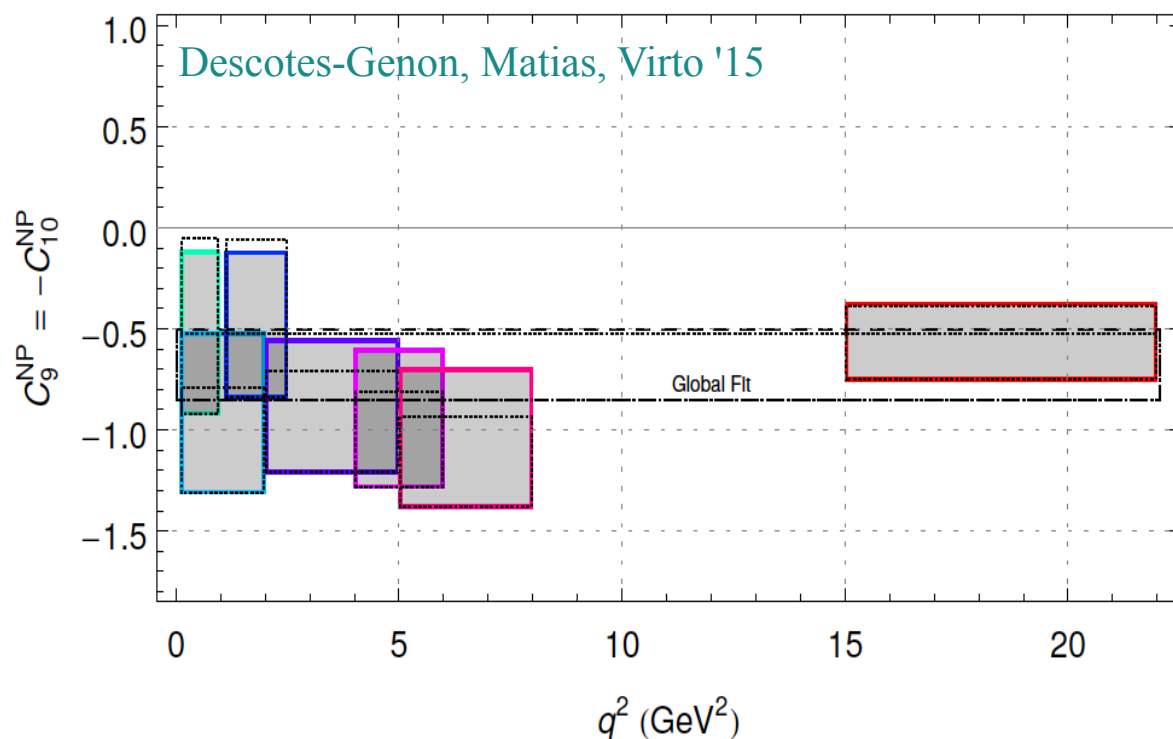

More precise data on the $q^2=m_{\mu\mu}$ distribution can help to distinguish NP vs. SM

► Implications for low-energy flavor physics

E.g: expectation of LFV processes in the PS³ model:

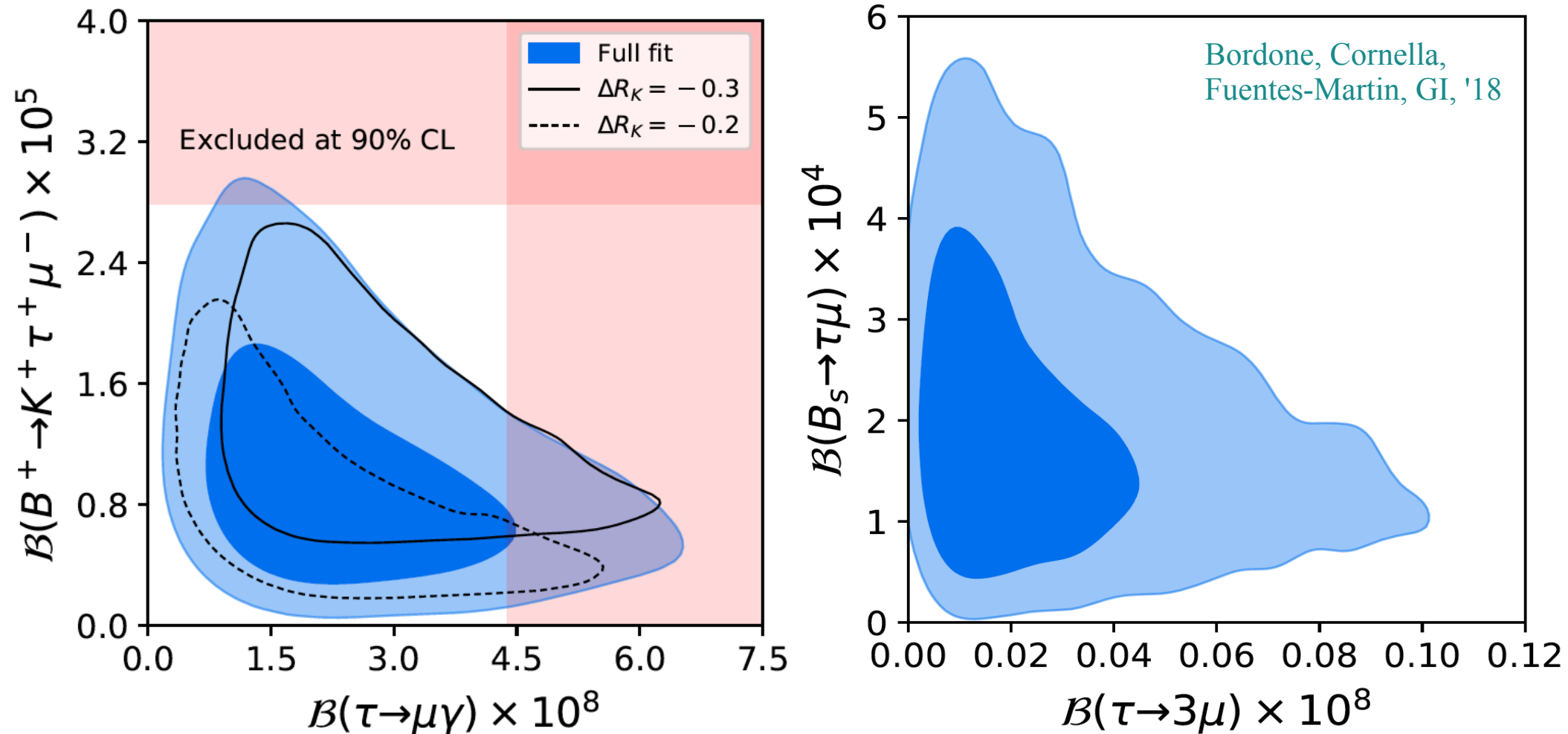

$$\left(\frac{\Delta R_D}{0.2}\right)^2 \left(\frac{\Delta R_K}{0.3}\right)^2 \approx 3 \left[\frac{\mathcal{B}(B \rightarrow K \tau^+ \mu^-)}{3 \times 10^{-5}}\right] \left[\frac{\mathcal{B}(\tau \rightarrow \mu \gamma)}{5 \times 10^{-8}}\right] \approx \left[\frac{\mathcal{B}(B_s \rightarrow \tau^\pm \mu^\mp)}{2 \times 10^{-4}}\right] \left[\frac{\mathcal{B}(\tau \rightarrow \mu \gamma)}{5 \times 10^{-8}}\right]$$

► Implications for low-energy flavor physics

If the anomalies are due to NP, we should expect to see several other BSM effects in low-energy observables

E.g.: correlations among down-type FCNCs [using the results of U(2)-based EFT]:

	$\mu\mu$ (ee)	$\tau\tau$	$\nu\nu$	$\tau\mu$	μe
$b \rightarrow s$	R_K, R_{K^*} O(20%)	$B \rightarrow K^{(*)} \tau\tau$ → 100×SM	$B \rightarrow K^{(*)} \nu\nu$ O(1)	$B \rightarrow K \tau\mu$ → ~10 ⁻⁵	$B \rightarrow K \mu e$???
$b \rightarrow d$	$B_d \rightarrow \mu\mu$ $B \rightarrow \pi \mu\mu$ $B_s \rightarrow K^{(*)} \mu\mu$ O(20%) [$R_K=R_\pi$]	$B \rightarrow \pi \tau\tau$ → 100×SM	$B \rightarrow \pi \nu\nu$ O(1)	$B \rightarrow \pi \tau\mu$ → ~10 ⁻⁷	$B \rightarrow \pi \mu e$???
$s \rightarrow d$	long-distance pollution	NA	$K \rightarrow \pi \nu\nu$ O(1)	NA	$K \rightarrow \mu e$ → ~10 ⁻¹²

► Implications for low-energy flavor physics

A similar table can be made also for charged currents, and in this case the predictions of the EFT are more simple/robust:

I) LH operators [universality of all $R^{\tau/\mu}(b \rightarrow c)$ ratios]:

$$\frac{R_D}{(R_D)_{SM}} = \frac{\Gamma(B \rightarrow D^* \tau \nu)/\Gamma_{SM}}{\Gamma(B \rightarrow D^* \mu \nu)/\Gamma_{SM}} = \frac{\Gamma(B_c \rightarrow \psi \tau \nu)/\Gamma_{SM}}{\Gamma(B_c \rightarrow \psi \mu \nu)/\Gamma_{SM}} = \frac{\Gamma(\Lambda_b \rightarrow \Lambda_c \tau \nu)/\Gamma_{SM}}{\Gamma(\Lambda_b \rightarrow \Lambda_c \mu \nu)/\Gamma_{SM}} = \dots$$

II) U(2) symmetry [$R^{\tau/\mu}(b \rightarrow c) = R^{\tau/\mu}(b \rightarrow u)$ universality]:

$$\frac{\Gamma(B \rightarrow \pi \tau \nu)/\Gamma_{SM}}{\Gamma(B \rightarrow \pi \mu \nu)/\Gamma_{SM}} = \frac{\Gamma(\Lambda_b \rightarrow p \tau \nu)/\Gamma_{SM}}{\Gamma(\Lambda_b \rightarrow p \mu \nu)/\Gamma_{SM}} = \frac{\Gamma(B_s \rightarrow K^* \tau \nu)/\Gamma_{SM}}{\Gamma(B_s \rightarrow K^* \mu \nu)/\Gamma_{SM}} = \dots = \frac{R_D}{(R_D)_{SM}}$$

N.B.: The only info on $b \rightarrow u \tau \nu$ we have is $BR(B_u \rightarrow \tau \nu)^{\text{exp}}/BR_{SM} = 1.31 \pm 0.27$

→ perfectly consistent with I+II

UTfit. '16

N.B.: The predictions for $R^{\mu/e}(b \rightarrow c)$ are more uncertain, but up to O(2%) possible

→ worth to improve

► Implications for high- p_T physics

Also as far as direct searches are concerned, 3rd gen. LQ are in good shape:

At high masses $pp \rightarrow \tau\tau$ is the most effective search mode

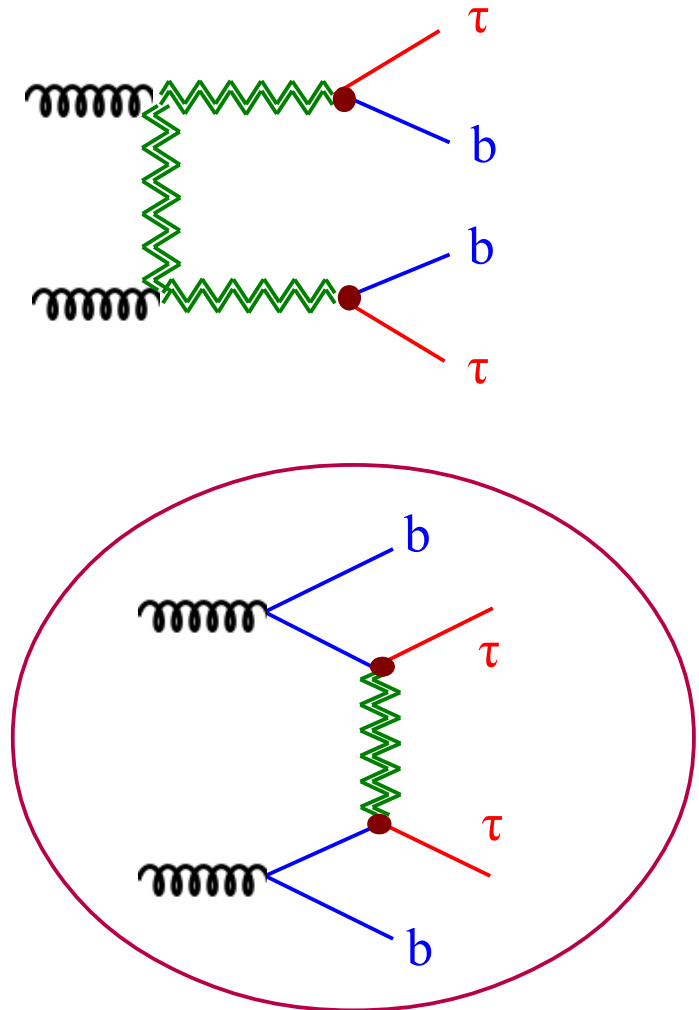
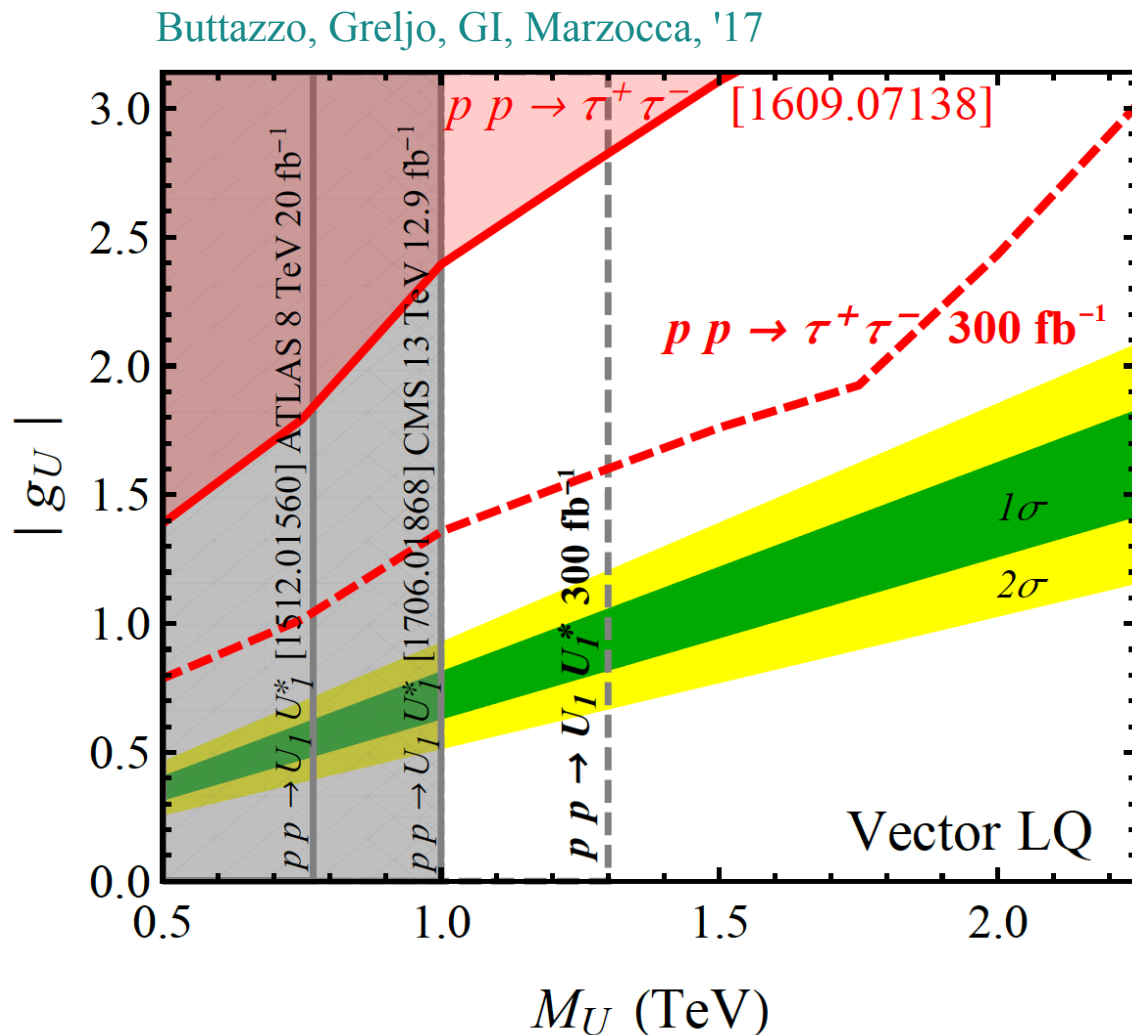

► Symmetry breaking pattern in PS³

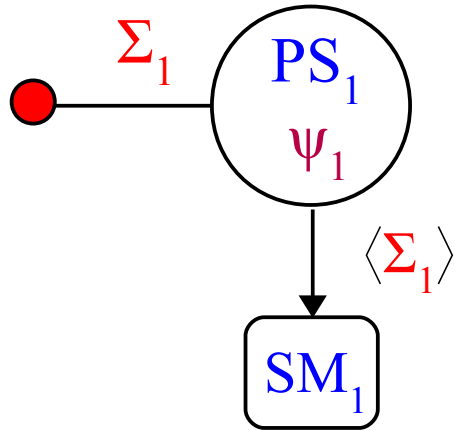

High-scale [$\sim 10^3$ TeV]
 “vertical” breaking [$PS \rightarrow SM$]

$$PS_1 [SU(4)_1 \times SU(2)_{R_1}]$$



$$SM_1 [SU(3)_1 \times U(1)_{Y_1}]$$

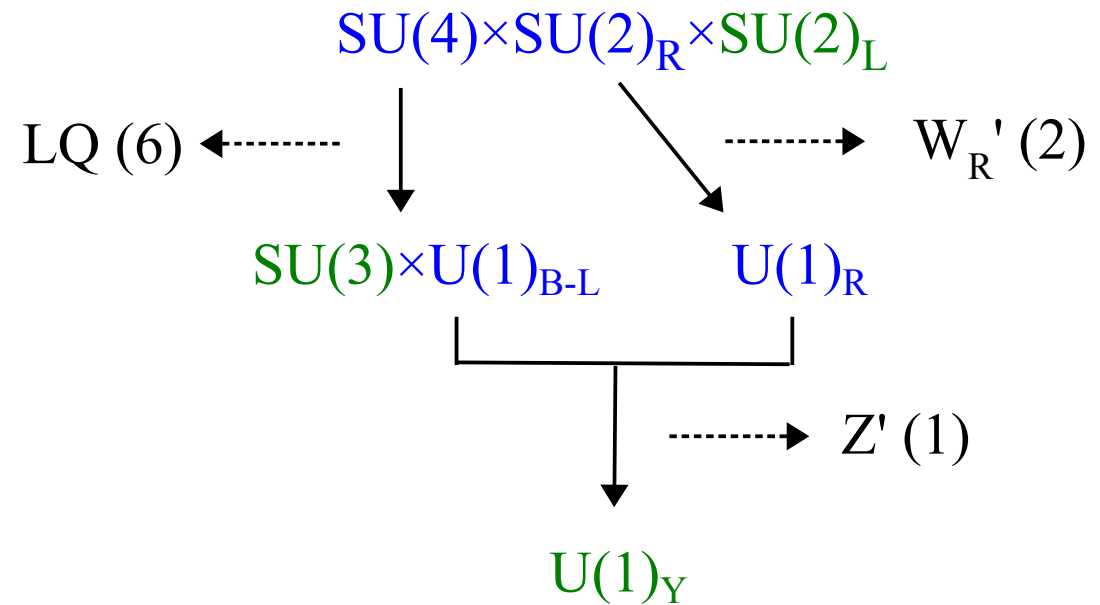

► Symmetry breaking pattern in PS³

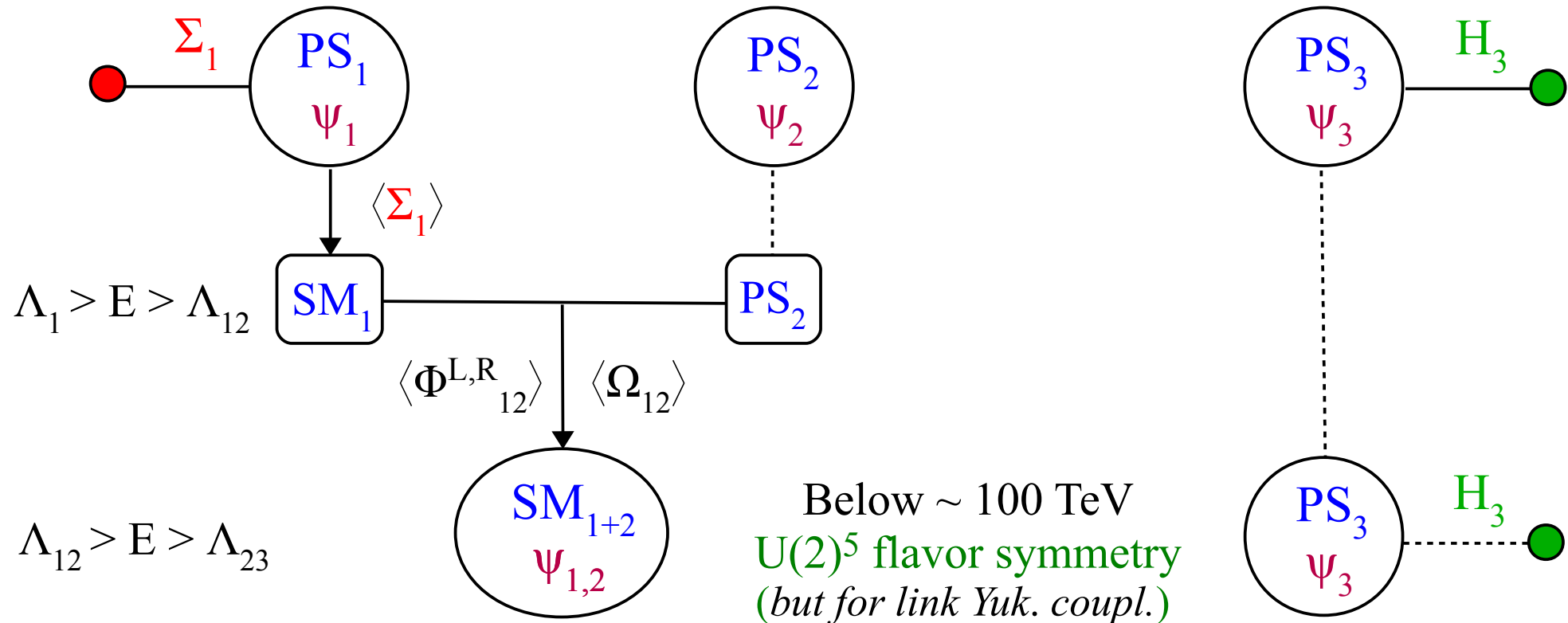

$$\Phi_{12}^L \sim (1,2,1)_1 \times (1,2,1)_2$$

$$\text{VEV} \rightarrow SU(2)_{1+2}^L$$

$$\Phi_{12}^R \sim (1,1,2)_1 \times (1,1,2)_2$$

$$\text{VEV} \rightarrow SU(2)_{1+2}^R$$

$$\Omega_{12} \sim (4,2,1)_1 \times (4,2,1)$$

$$\text{VEV} \rightarrow SU(4)_{1+2} \ \& \ SU(2)_{1+2}^L$$