

Highlights on XYZ (charmonium-like) states and recent results on light hadron spectroscopy from **BESIII**

Hao Cai

Wuhan University, P. R. China

2014 Flavour Physics Conference, Quy Nhon, Vietnam

July 29th, 2014

Outline

- ▶ Introduction
 - ▶ BEPCII
 - ▶ BESIII
 - ▶ Data set
- ▶ XYZ Physics
- ▶ Light hadron spectroscopy
- ▶ Summary

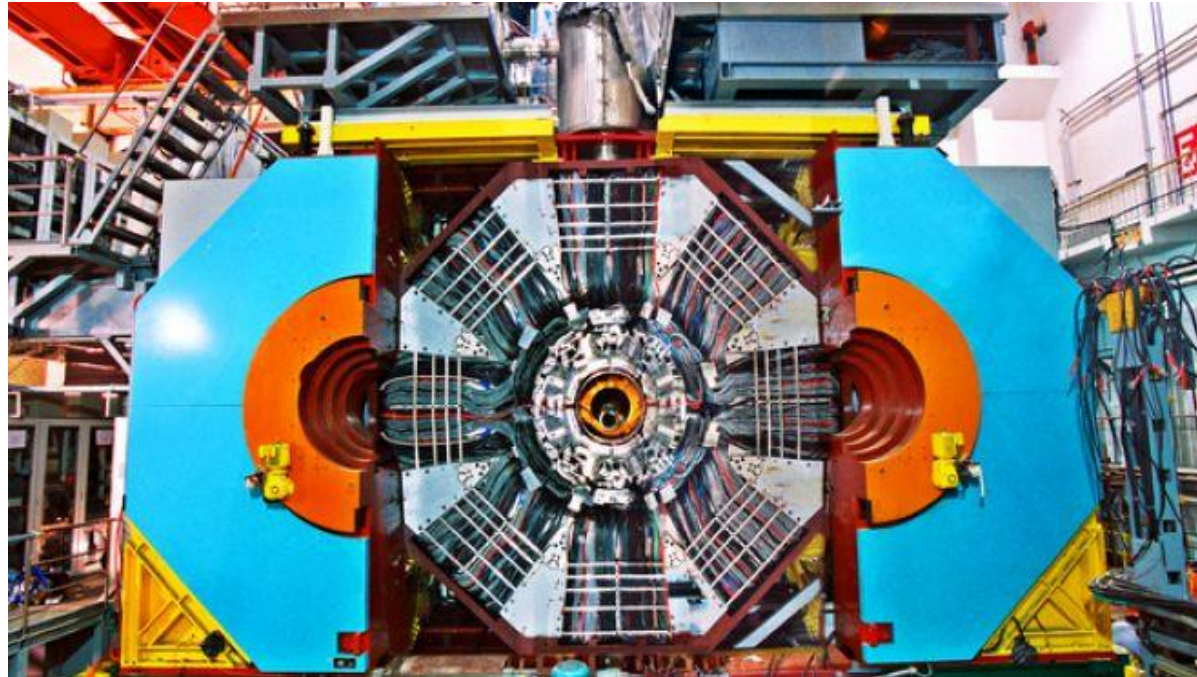

BEPCII

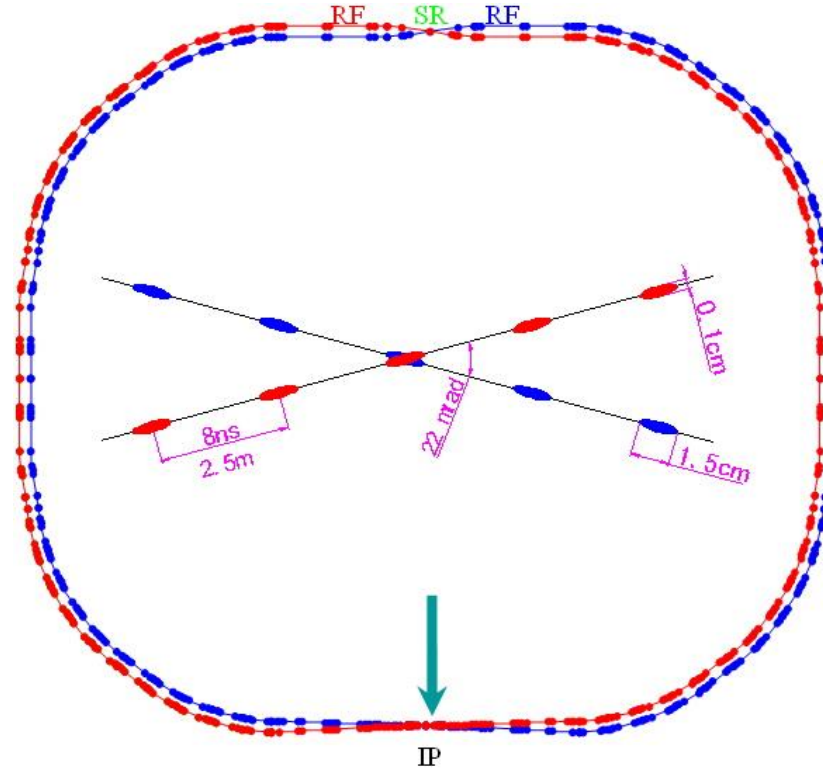

Beam energy range	1-2.3 GeV
Optimized beam energy region	1.89 GeV
Current of each beam in collision	0.93 A
Luminosity achieved	$0.7 \times 10^{33} \text{ cm}^{-2} \text{ s}^{-1}$
Beam lifetime	2.7 hrs
SR mode	0.25 A@2.5 GeV

BESIII

Main Drift Chamber (MDC):

$$\sigma_{xy} = 135 \mu m$$

$$\Delta P/P = 0.5\% @ 1 GeV$$

$$\sigma_{dE/dx} = 6\sim 7\%$$

TOF System:

$$\sigma_T = 80 \text{ ps @barrel}$$

$$110 \text{ ps @endcap}$$

EM Calorimeter (EMC):

$$\Delta E/E = 2.5\% @ 1 GeV$$

$$\sigma_{z,\phi} = 0.6 \text{ cm @ 1 GeV}$$

Barrel and endcap have
different performance

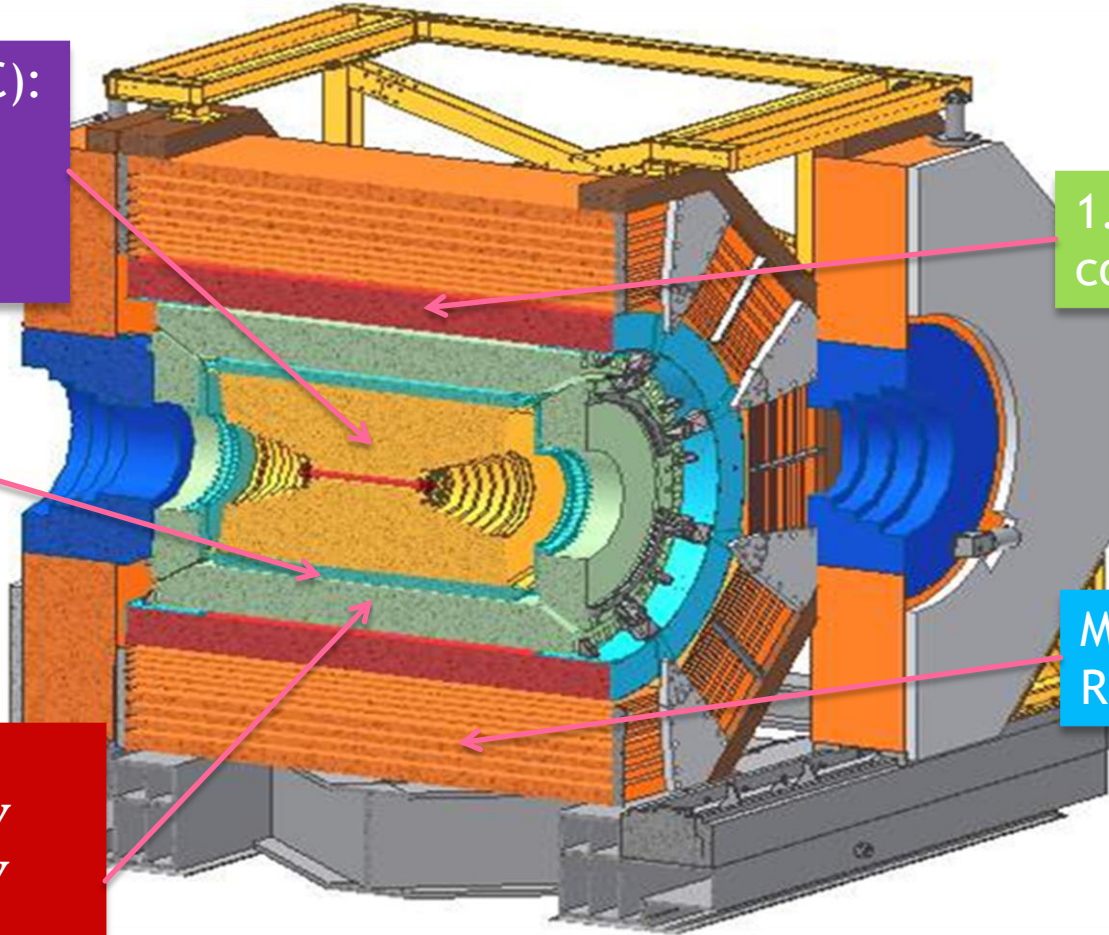

1.0 Tesla Super-
conducting Magnet

Muon Chamber (MUC):
RPC based

BESIII Collaboration

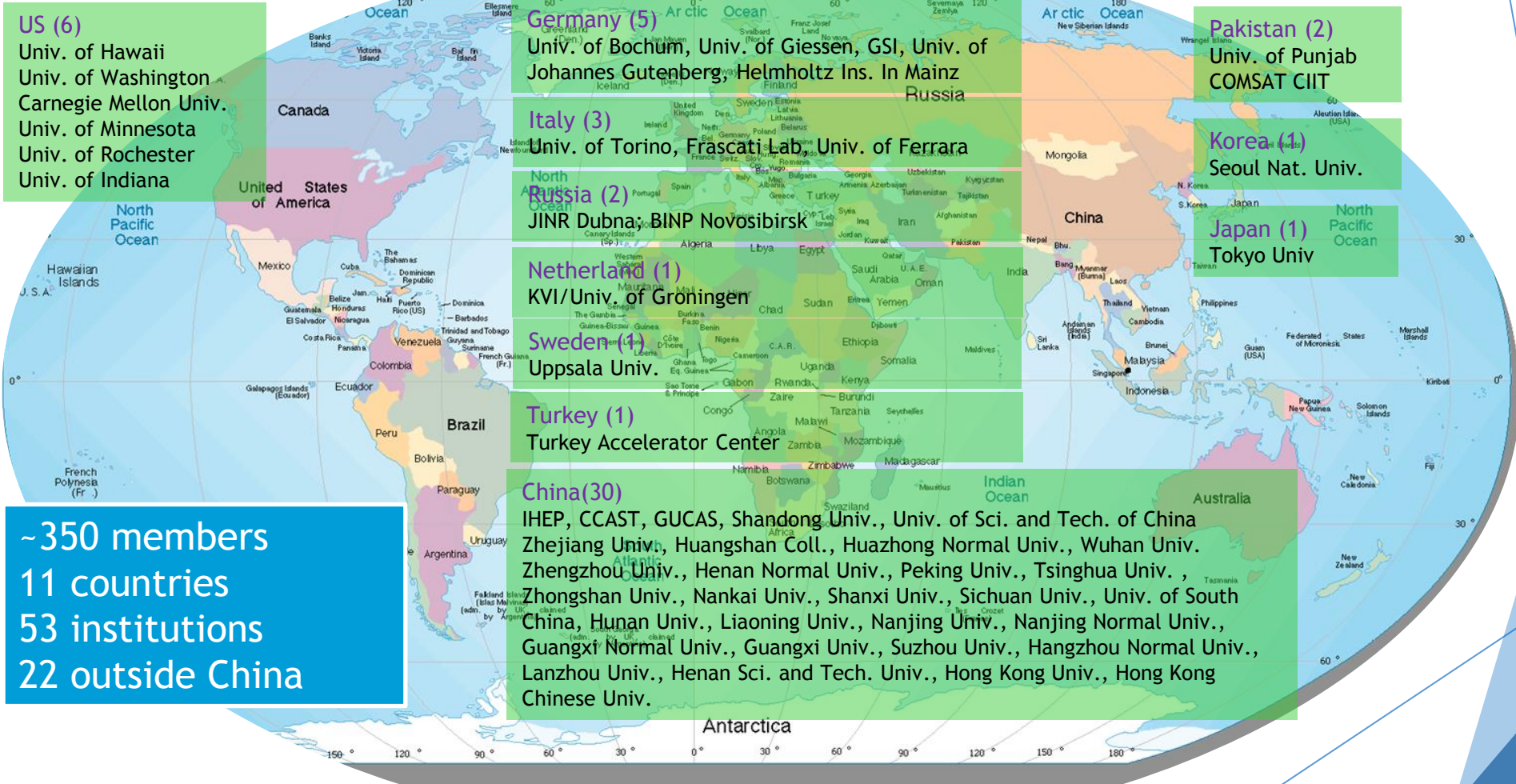

BESIII started data taking for physics since 2009

1.3×10^9	J/Ψ @ 3.097 GeV	2009 (0.225×10^9) + 2012
0.5×10^9	Ψ' @ 3.686 GeV	2009 (0.106×10^9) + 2012
2.9 fb^{-1}	$\Psi(3770)$ @ 3.773 GeV	2010 + 2011
0.5 fb^{-1}	$\Psi(4040)$ @ 4.009 GeV	2011
0.024 fb^{-1}	τ mass scan at around 3.554 GeV	2011
1.9 fb^{-1}	$Y(4260)$ @ 4.23 and 4.26 GeV	2013
0.5 fb^{-1}	$Y(4360)$ @ 4.36 GeV	2013
0.5 fb^{-1}	$Y(4260)$ and $Y(4360)$ scan	2013
0.8 fb^{-1}	R scan, 104 energy points between 3.85 and 4.59 GeV	2014
1.0 fb^{-1}	@ 4.42 GeV	2014
0.1 fb^{-1}	@ 4.47 GeV	2014
0.1 fb^{-1}	@ 4.53 GeV	2014
0.04 fb^{-1}	@ 4.575 GeV	2014
0.5 fb^{-1}	@ 4.60 GeV	2014

XYZ (charmonium-like)
physics at **BESIII**

The Landscape

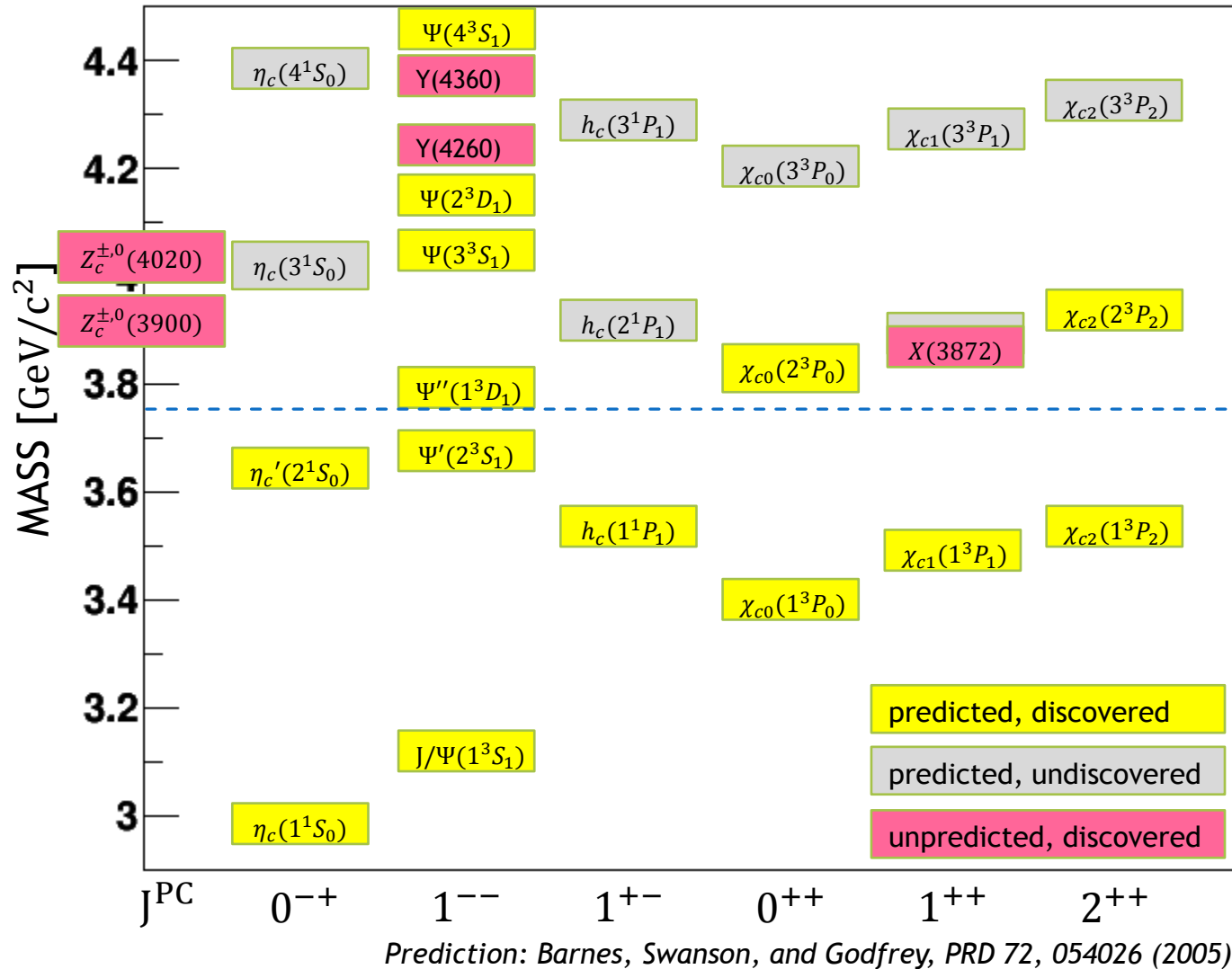

- ▶ All states below $D\bar{D}$ threshold have been observed
- ▶ Many missing states above $D\bar{D}$ threshold
- ▶ Pattern of masses
- ▶ Transitions between states

Y(4260)

- ▶ $J^{PC} = 1^{--}$ state produced in $e^+e^- \rightarrow \gamma_{ISR} \pi^+ \pi^- J/\psi$
- ▶ OZI favored decay is expected, but no obvious enhanced open-charm channel is observed

Final state (X)	$\frac{\sigma(Y(4260) \rightarrow X)}{\sigma(Y(4260) \rightarrow \pi^+ \pi^- J/\psi)}$
$D\bar{D}$	<4.0
$D^*\bar{D}$	<45
$D^*\bar{D}^*$	<11
$D^*\bar{D}\pi$	<15
$D^*\bar{D}^*\pi$	<8.2
$D_s^+ D_s^-$	<1.3
$D_s^{*+} D_s^-$	<0.8
$D_s^{*+} D_s^{*-}$	<9.5

CLEO-c

PRD 80, 072001 (2009)

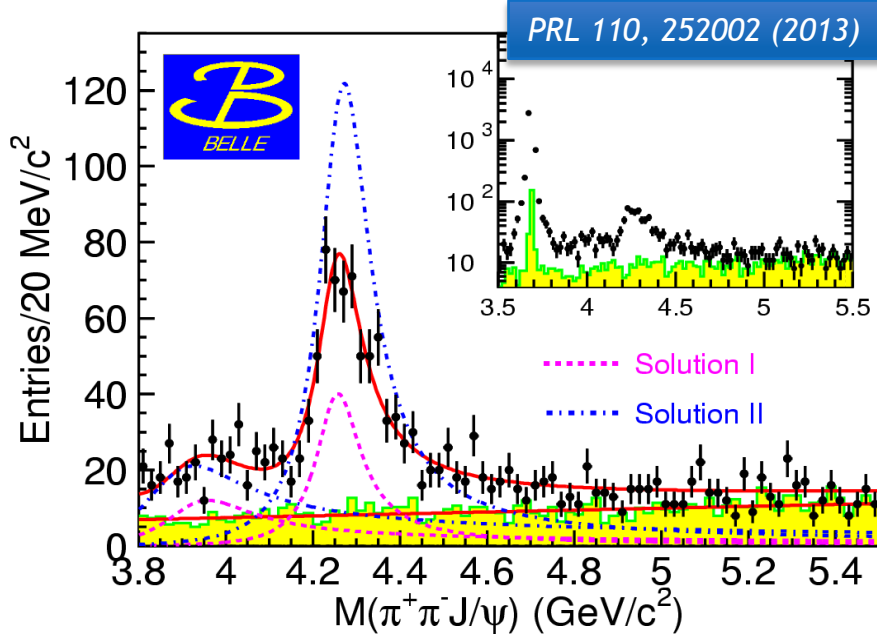
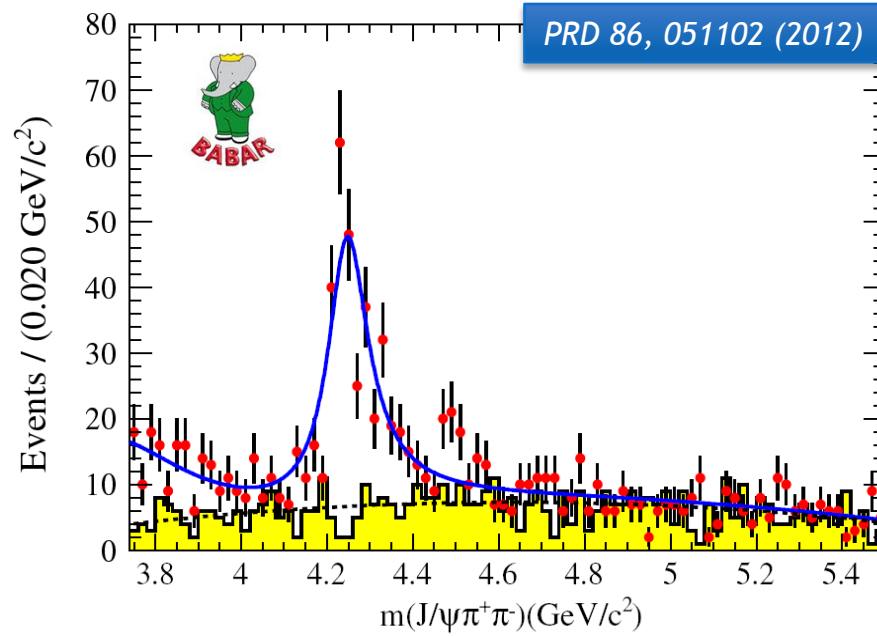

Y(4360)

- ▶ Similar to Y(4260), 1^{--} state produced in $e^+e^- \rightarrow \gamma_{ISR} \pi^+ \pi^- \Psi'$
- ▶ Additional state at 4660 MeV
- ▶ Nature of Y states is unknown
- ▶ The interference effect among them is large
- ▶ Dedicated running at BESIII starting in 2013 winter

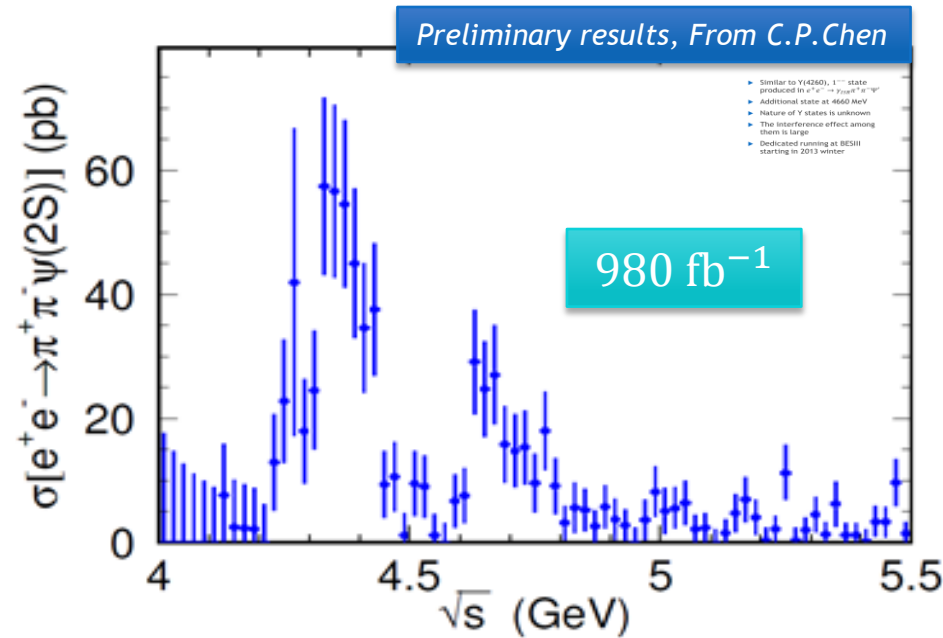
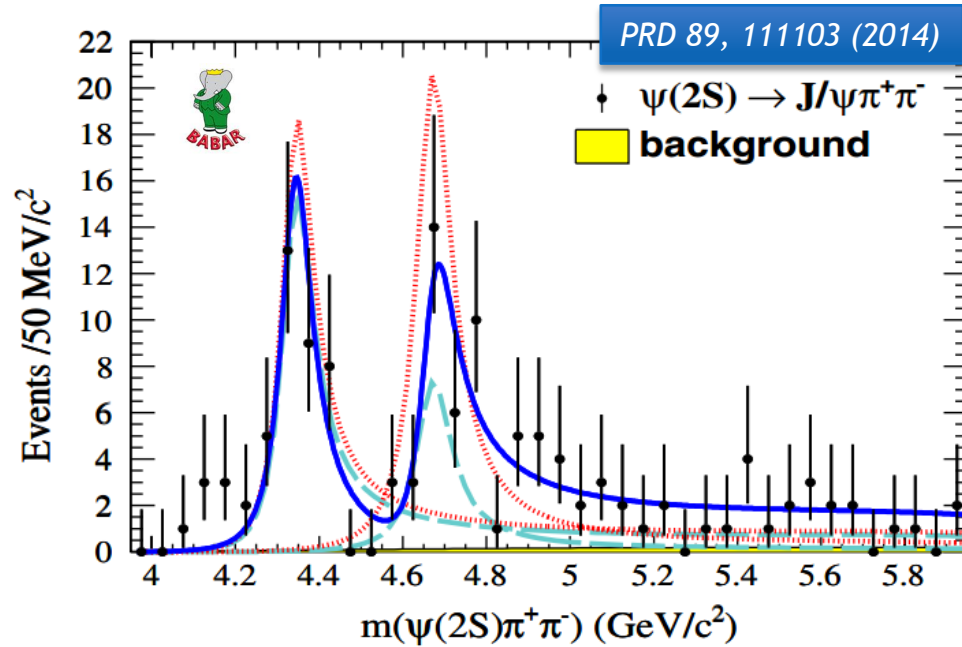

$e^+e^- \rightarrow \pi^+\pi^- J/\Psi$ at $E_{cm} = 4260$ MeV

- ▶ $\pi\pi J/\Psi$ is the only firmly established decay mode of $Y(4260)$

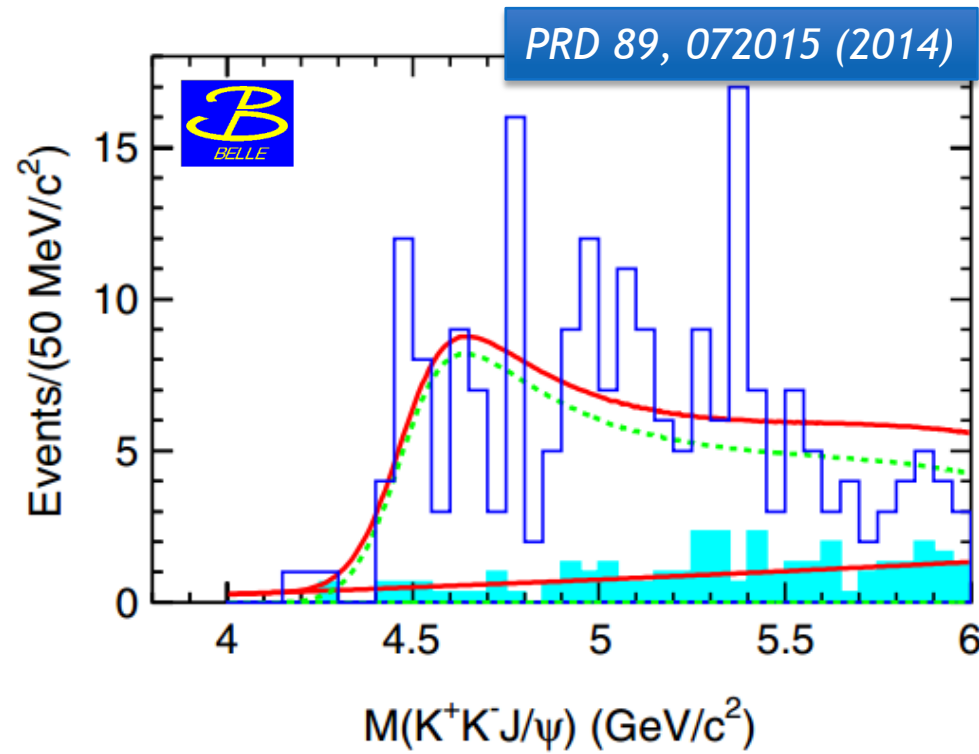
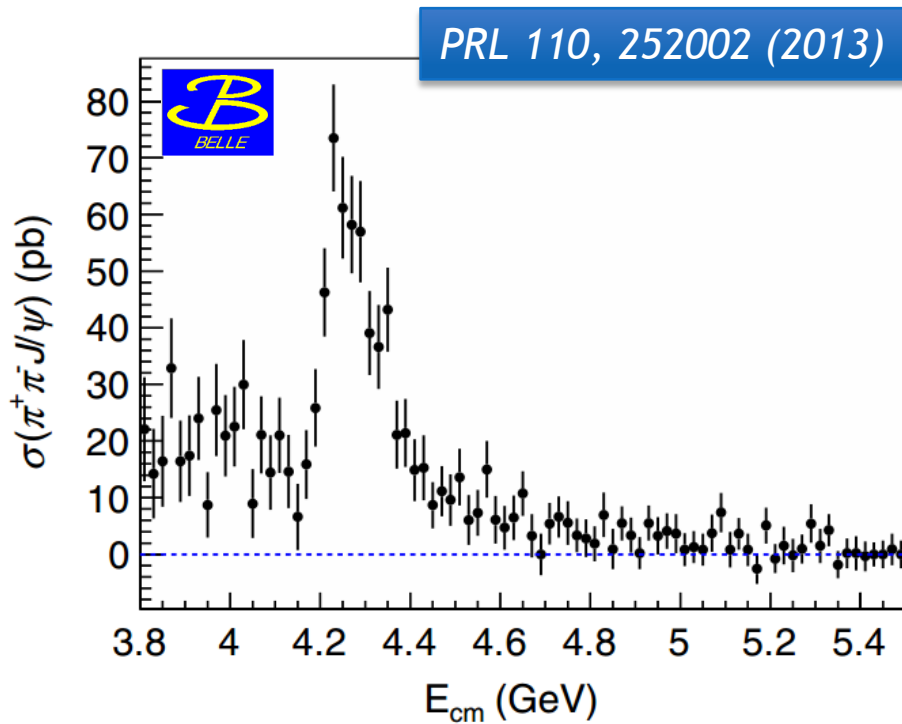

$e^+e^- \rightarrow \pi^+\pi^- J/\psi$ at $E_{cm} = 4260$ MeV

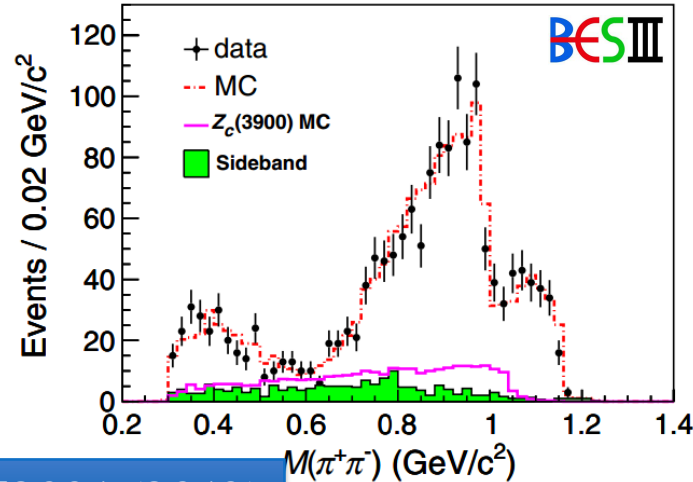
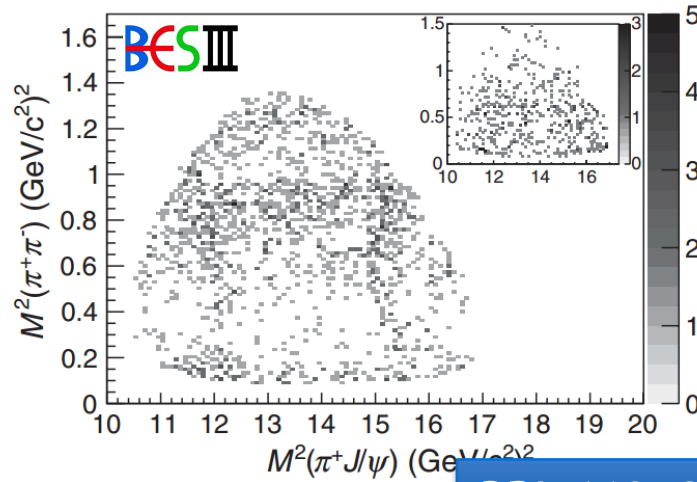

PRL 110, 252001 (2013)

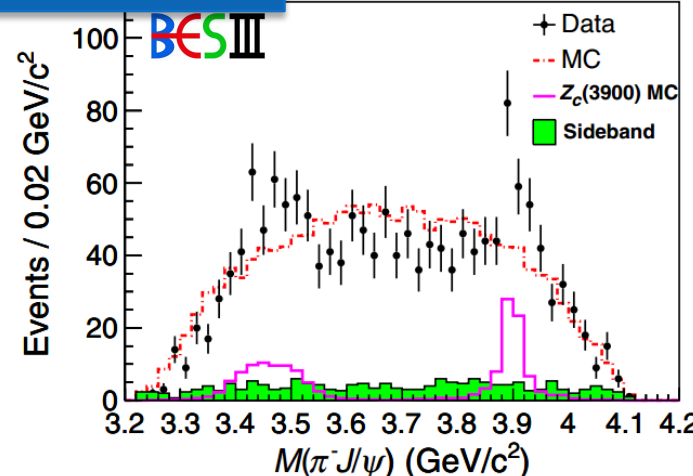
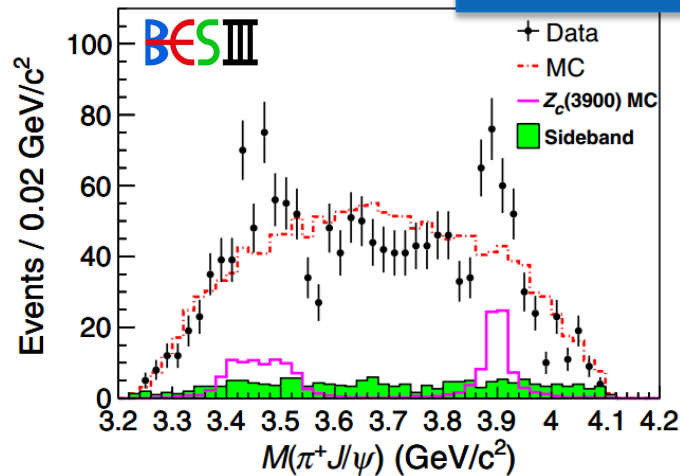

- ▶ Lum = 525 pb⁻¹
- ▶ Born cross section is $(62.9 \pm 1.9 \pm 3.7)$ pb
- ▶ Analysis is valid and unbiased

Discovery of $Z_c^\pm(3900)$

- ▶ $Z_c^\pm(3900) \rightarrow \pi^\pm J/\psi$
- ▶ First confirmed particle made of four quarks
- ▶ More data is needed

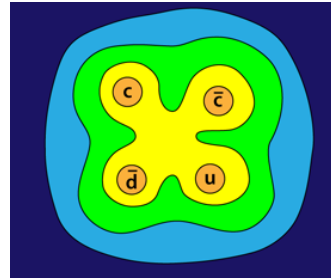

Viewpoint: New Particle Hints at Four-Quark Matter
<http://physics.aps.org/articles/v6/69>

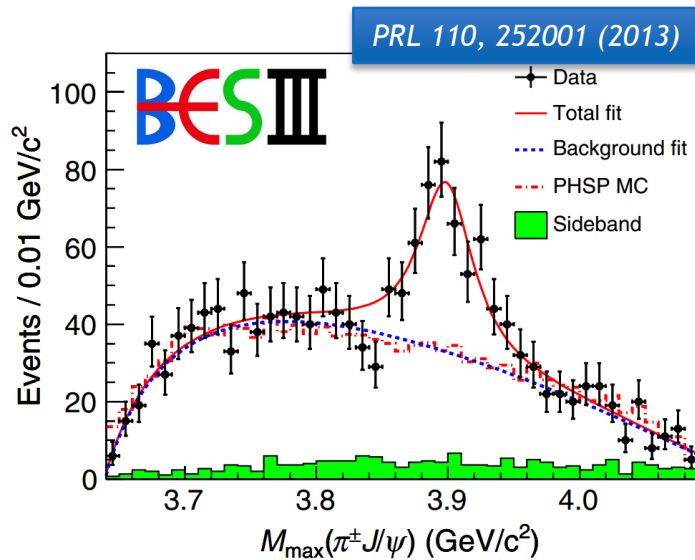

$M = (3899.0 \pm 3.6 \pm 4.9)\text{MeV}$
 $\Gamma = (46 \pm 10 \pm 20)\text{MeV}$

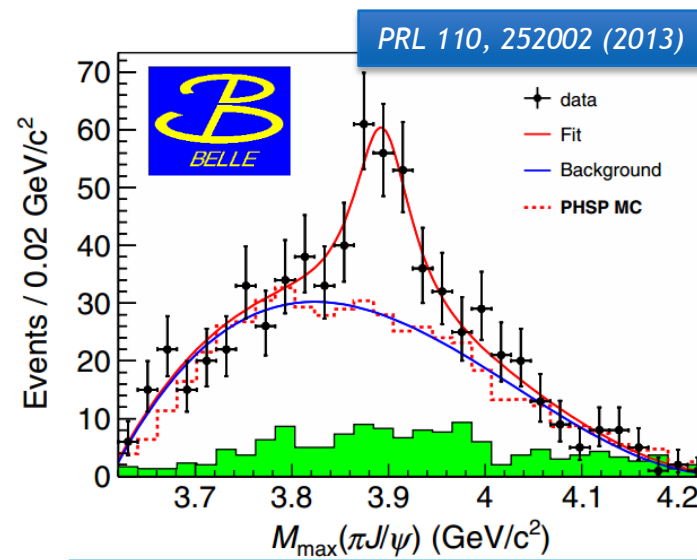

$M = (3894.5 \pm 6.6 \pm 4.5)\text{MeV}$
 $\Gamma = (63 \pm 24 \pm 26)\text{MeV}$

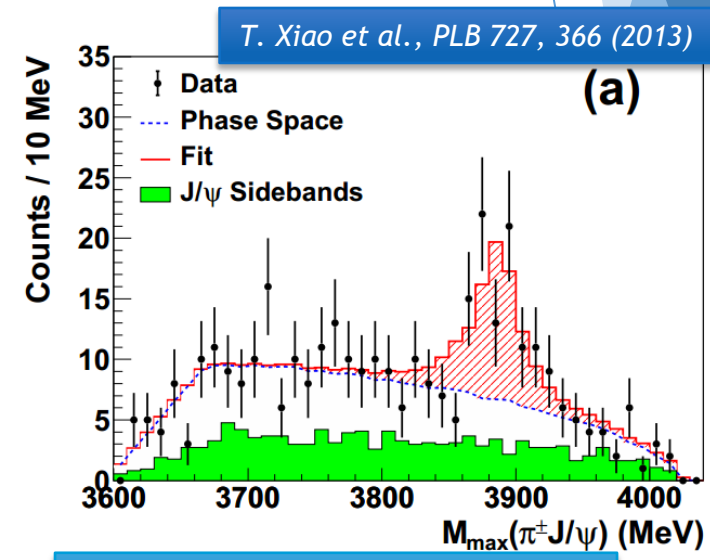

$M = (3886 \pm 6 \pm 4)\text{MeV}$
 $\Gamma = (33 \pm 6 \pm 7)\text{MeV}$

$Z_c^0(3900)$

- ▶ Evidence of neutral iso-spin partner is observed in $e^+e^- \rightarrow \pi^0\pi^0 J/\psi$
- ▶ Production correlated with $Y(4260)$ is suggestive

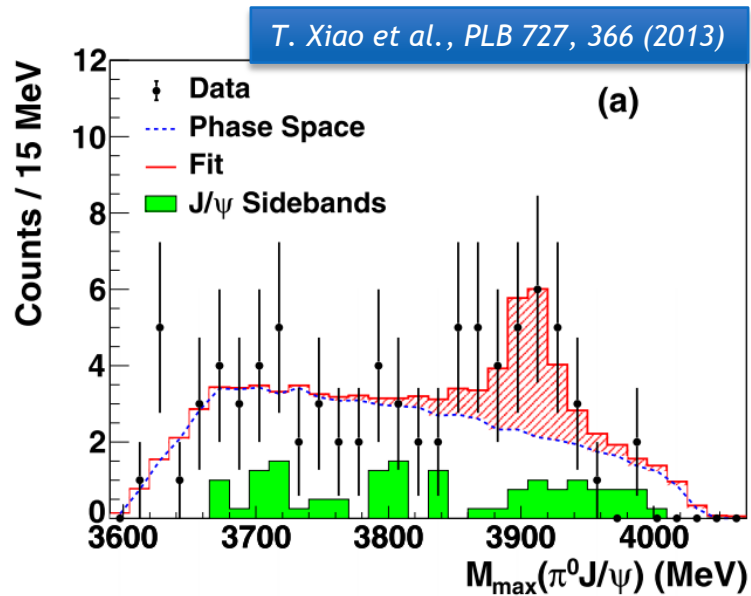

$$M = (3886 \pm 6 \pm 4)\text{MeV}$$
$$\Gamma = (33 \pm 6 \pm 7)\text{MeV}$$

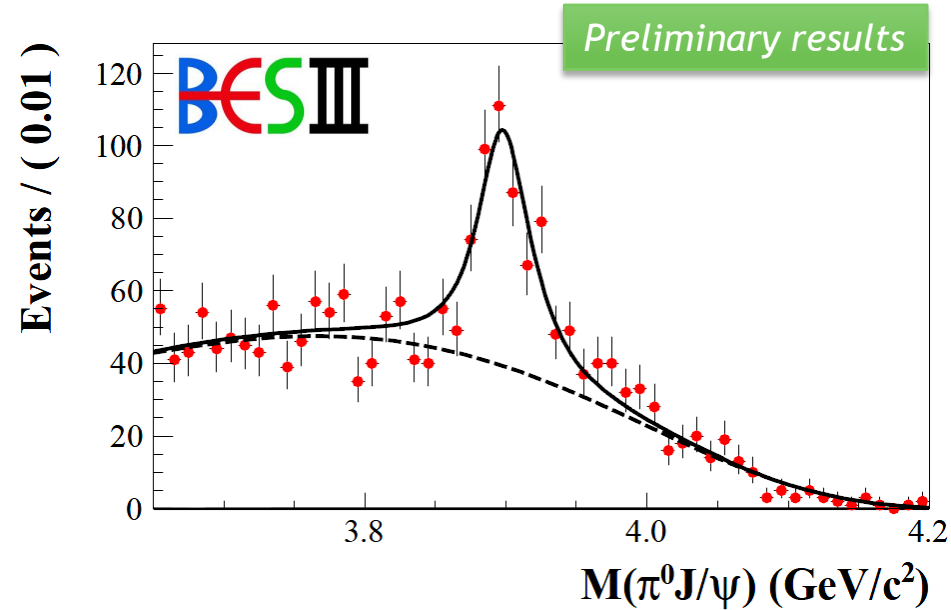

$$M = (3894.8 \pm 2.3 \pm 2.6)\text{MeV}$$
$$\Gamma = (29.6 \pm 8.2 \pm 7.3)\text{MeV}$$

$e^+e^- \rightarrow \pi^\pm (D\bar{D}^*)^\mp @ 4260 \text{ MeV}$

- ▶ $Z_c(3885)$ is observed in the $D\bar{D}^*$ invariant mass
- ▶ If $Z_c(3885)$ is $Z_c(3900)$

$$\frac{\Gamma(Z_c(3900) \rightarrow D\bar{D}^*)}{\Gamma(Z_c(3900) \rightarrow \pi J/\Psi)} = 6.2 \pm 2.9$$
 much smaller than that of conventional charmonium states
- ▶ π angular distribution favors $J^P = 1^+$

$$M[Z_c(3900)] = (3899.0 \pm 3.6 \pm 4.9) \text{ MeV}$$

$$\Gamma[Z_c(3900)] = (46 \pm 10 \pm 20) \text{ MeV}$$

$$M[Z_c(3885)] = 3884 \pm 4 \text{ MeV}$$

$$\Gamma[Z_c(3885)] = 25 \pm 11 \text{ MeV}$$

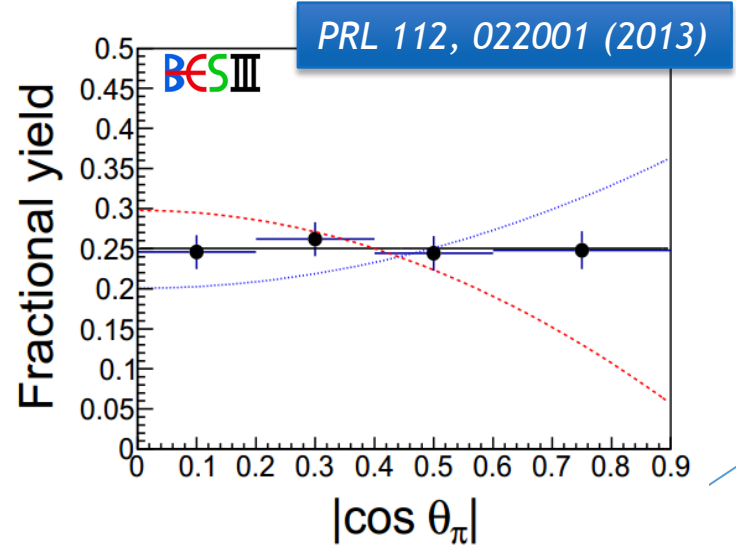
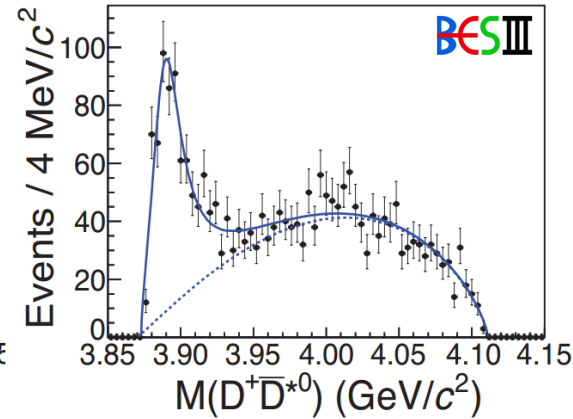
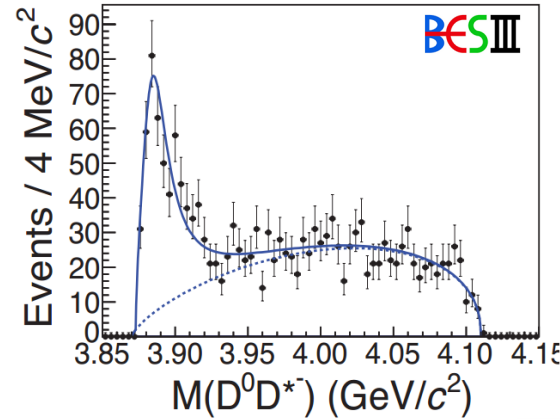

$e^+e^- \rightarrow \pi^+\pi^-h_c$

- ▶ Significant $\pi^+\pi^-h_c$ production at $E_{cm} = 4170$ MeV
- ▶ h_c is spin singlet ($S=0$) state different from J/ψ
- ▶ Correlated with $Y(4260)$?
- ▶ $\sigma(\pi^+\pi^-h_c)$ cross sections are comparable to $\sigma(\pi^+\pi^-J/\psi)$
- ▶ Search for $\pi^\pm h_c$ states
- ▶ $e^+e^- \rightarrow \pi^0\pi^0h_c$ is also interesting

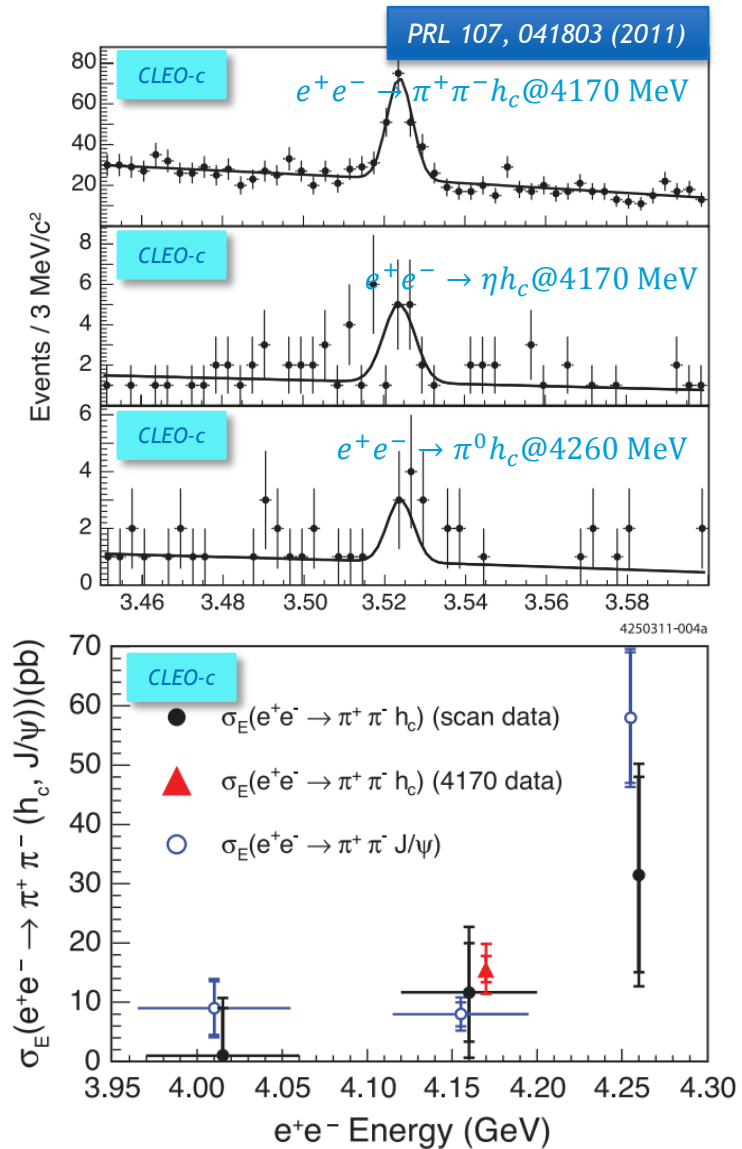

Discovery of $Z_c^\pm(4020)$

- ▶ No sharp structure in $\pi^+\pi^-h_c$ section, correlation with $Y(4260)$ or $Y(4360)$ unclear
- ▶ Narrow $\pi^\pm h_c$ structure observed
- ▶ No significance for $Z_c(3900) \rightarrow \pi^\pm h_c$

@ 4260 MeV

$$\sigma(e^+e^- \rightarrow \pi^\pm Z_c^\mp(3900) \rightarrow \pi^+\pi^-h_c) < 11 \text{ pb @90\% C.L.}$$

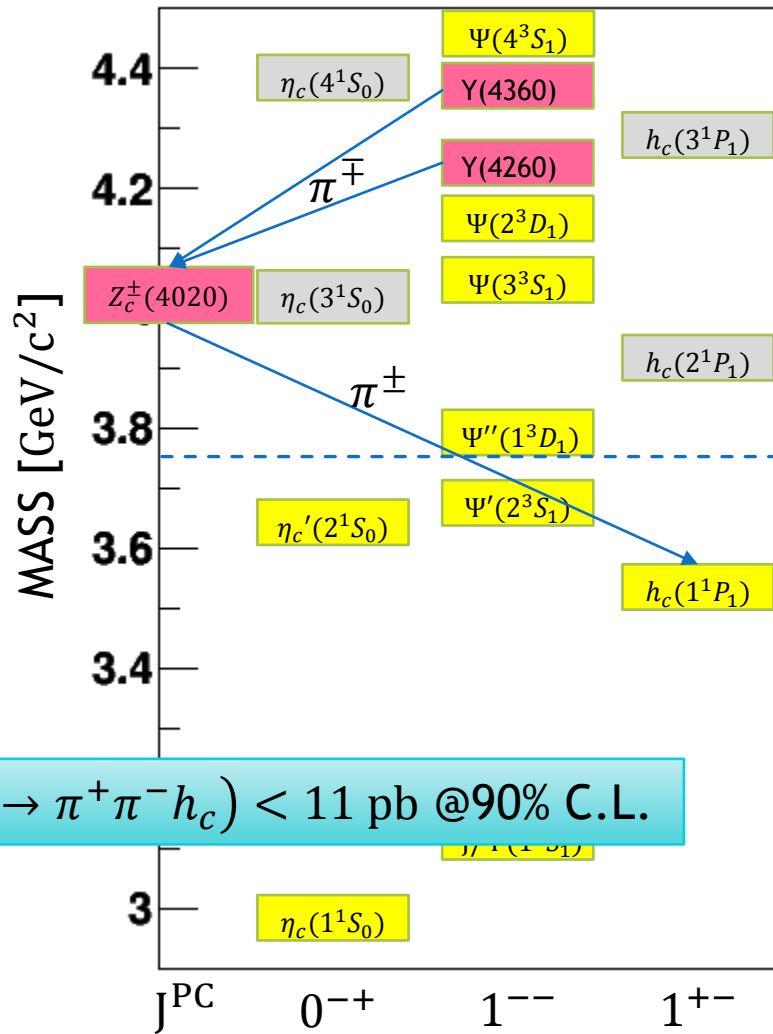

PRL 111, 242001 (2013)

\sqrt{s} (GeV)	\mathcal{L} (pb ⁻¹)	$n_{h_c}^{\text{obs}}$	$\sigma(e^+e^- \rightarrow \pi^+\pi^-h_c)$ (pb)
3.900	52.8	<2.3	<8.3
4.009	482.0	<13	<5.0
4.090	51.0	<6.0	<13
4.190	43.0	8.8 ± 4.9	$17.7 \pm 9.8 \pm 1.6 \pm 2.8$
4.210	54.7	21.7 ± 5.9	$34.8 \pm 9.5 \pm 3.2 \pm 5.5$
4.220	54.6	26.6 ± 6.8	$41.9 \pm 10.7 \pm 3.8 \pm 6.6$
4.230	1090.0	646 ± 33	$50.2 \pm 2.7 \pm 4.6 \pm 7.9$
4.245	56.0	22.6 ± 7.1	$32.7 \pm 10.3 \pm 3.0 \pm 5.1$
4.260	826.8	416 ± 28	$41.0 \pm 2.8 \pm 3.7 \pm 6.4$
4.310	44.9	34.6 ± 7.2	$61.9 \pm 12.9 \pm 5.6 \pm 9.7$
4.360	544.5	357 ± 25	$52.3 \pm 3.7 \pm 4.8 \pm 8.2$
4.390	55.1	30.0 ± 7.8	$41.8 \pm 10.8 \pm 3.8 \pm 6.6$
4.420	44.7	29.1 ± 7.3	$49.4 \pm 12.4 \pm 4.5 \pm 7.6$

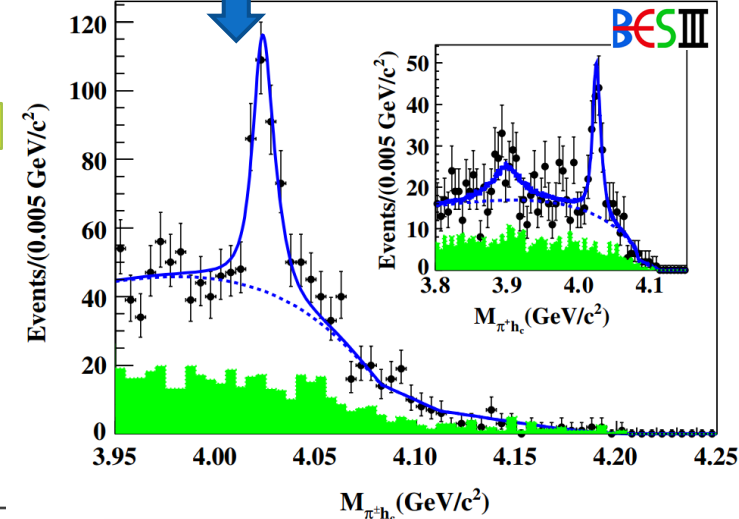

$$M[Z_c(4020)] = 4023 \pm 3 \text{ MeV}$$

$$\Gamma[Z_c(4020)] = 8 \pm 4 \text{ MeV}$$

$Z_c^0(4020)$

- ▶ Using data collected @4.23, 4.26 and 4.36 GeV to study $e^+e^- \rightarrow \pi^0\pi^0 h_c$
- ▶ The Born cross sections are found to be about half of those of $e^+e^- \rightarrow \pi^+\pi^- h_c$
- ▶ Evidence of neutral iso-spin partner of $Z_c^\pm(4020)$

$$M = (4023.6 \pm 2.2 \pm 3.9)\text{MeV}$$

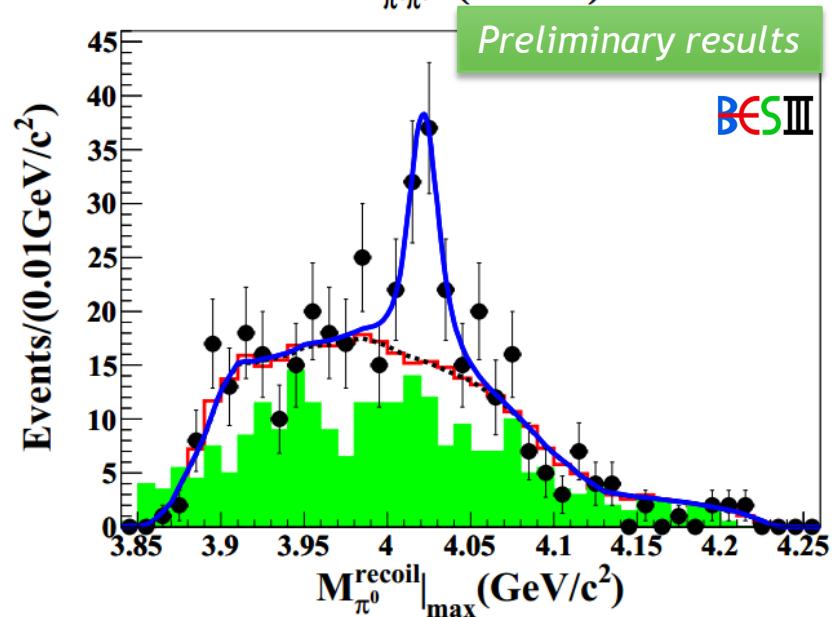
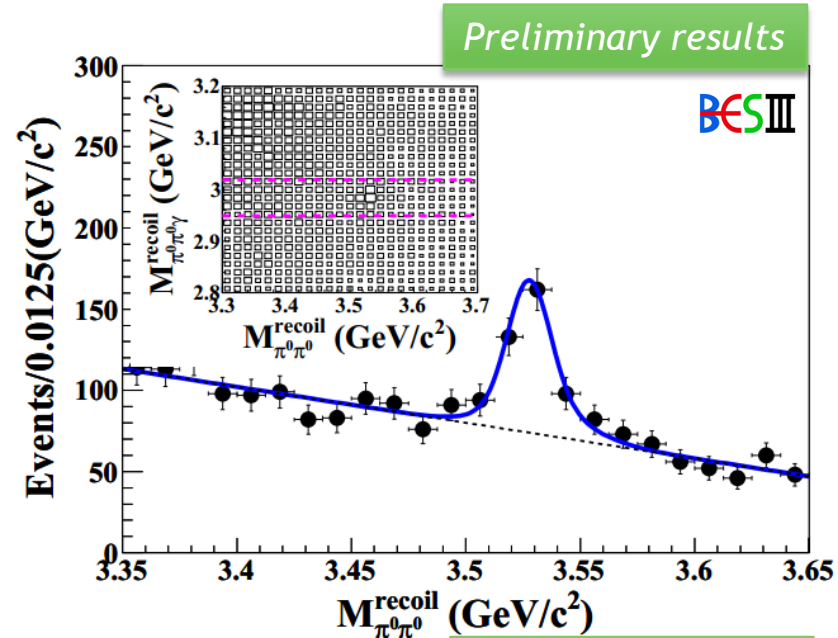

$e^+e^- \rightarrow \pi^\pm (D^* \overline{D}^*)^\mp$ at $E_{\text{cm}} = 4260 \text{ MeV}$

- ▶ Deviation from phase space decay; Described by a charged state $Z_c^\pm(4025)$ decaying to $D^* \overline{D}^*$
- ▶ If $Z_c^\pm(4025)$ is the $Z_c^\pm(4020)$ observed in the $\pi^\pm h_c$ spectrum

$$\frac{\Gamma(Z_c(4020) \rightarrow D^* \overline{D}^*)}{\Gamma(Z_c(4020) \rightarrow \pi h_c)} = 12 \pm 5$$

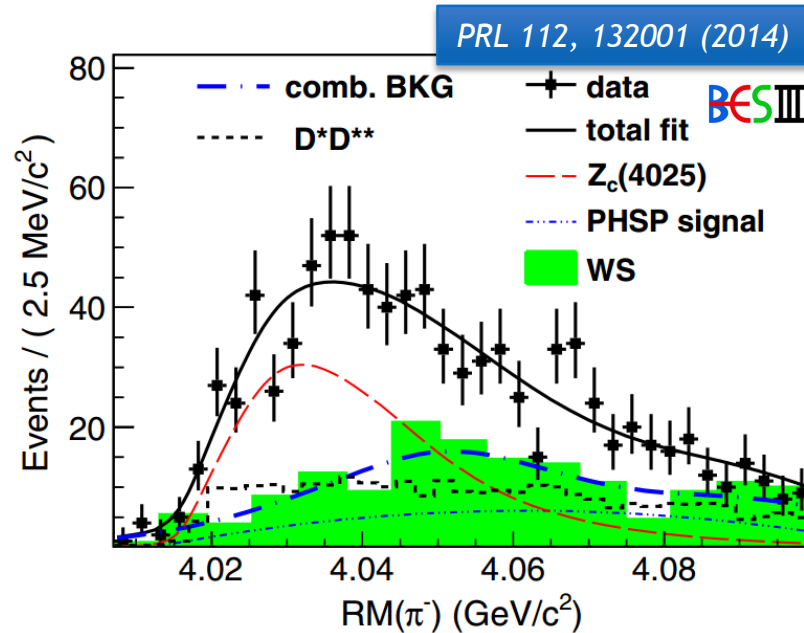

$$M[Z_c(4025)] = 4026 \pm 3 \text{ MeV}$$

$$\Gamma[Z_c(4025)] = 25 \pm 6 \text{ MeV}$$

$$M[Z_c(4020)] = 4023 \pm 3 \text{ MeV}$$

$$\Gamma[Z_c(4020)] = 8 \pm 4 \text{ MeV}$$

$Z_c^{\pm,0}(4020)$ and $Z_c^{\pm,0}(3900)$

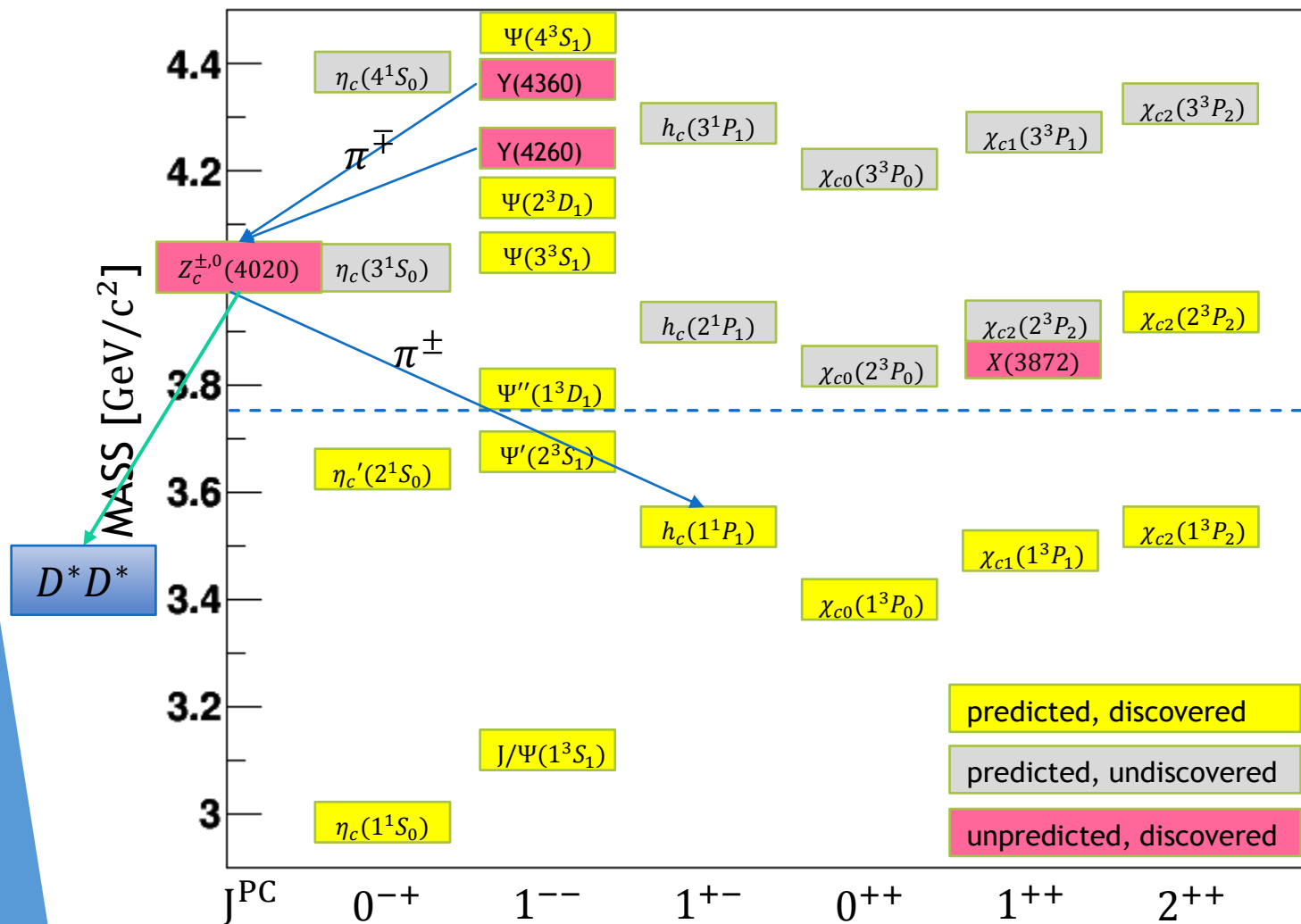

- ▶ Qualitatively similar to each other
- ▶ Correlation with Y(4360) or Y(4260) is clear or not?

$Z_c^{\pm,0}(4020)$ and $Z_c^{\pm,0}(3900)$

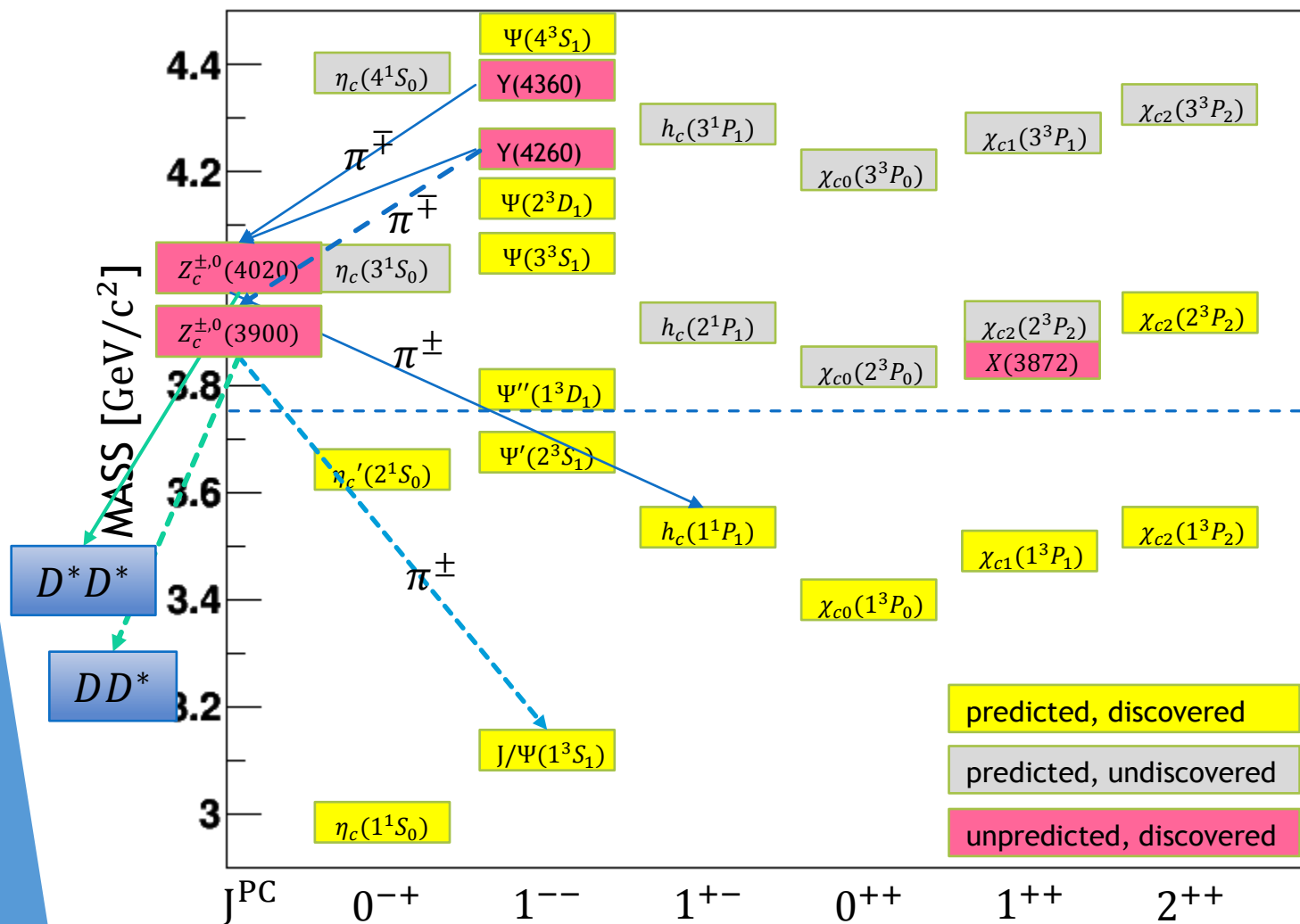

- ▶ Qualitatively similar to each other
- ▶ Correlation with Y(4360) or Y(4260) is clear or not?

$Z_c^{\pm,0}(4020)$ and $Z_c^{\pm,0}(3900)$

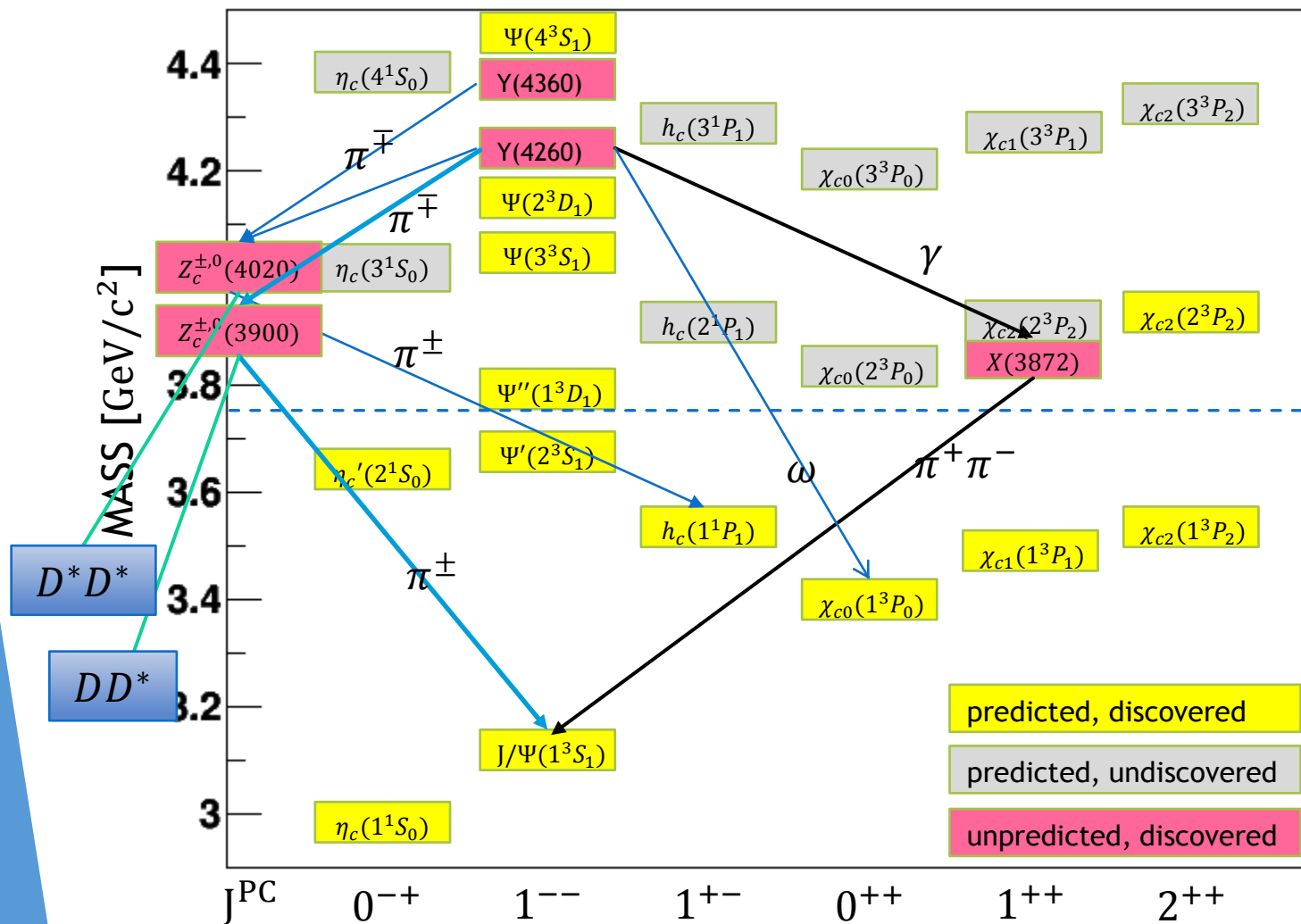

- ▶ Qualitatively similar to each other
- ▶ Correlation with Y(4360) or Y(4260) is clear or not?
- ▶ More interesting results

X(3872)

- ▶ Mass: Very close to $D^0 D^{*0}$ threshold
- ▶ Width: Very narrow (< 1.2 MeV)
- ▶ $J^{PC} = 1^{++}$
- ▶ Radiative transition to J/Ψ is observed
- ▶ Nature:
 - ▶ Bound $D^0 \overline{D^{*0}}$ “molecular” state?
 - ▶ Mixture of excited χ_{c1} and $D^0 \overline{D^{*0}}$ bound state?
 - ▶ If it is not χ'_{c1} , where is χ'_{c1} ?

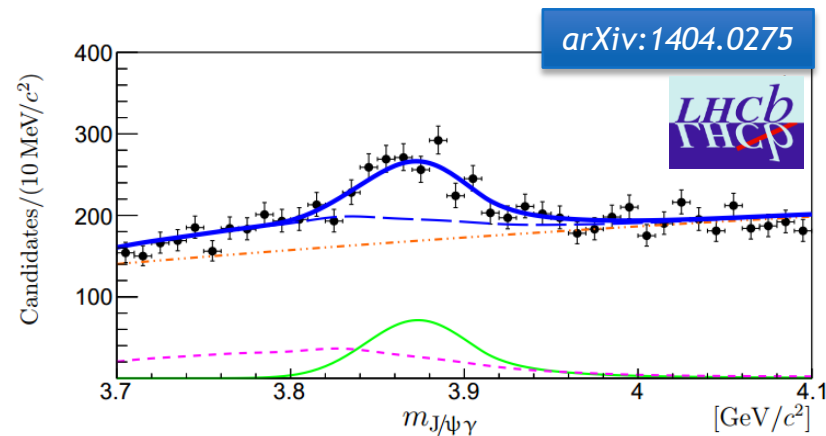
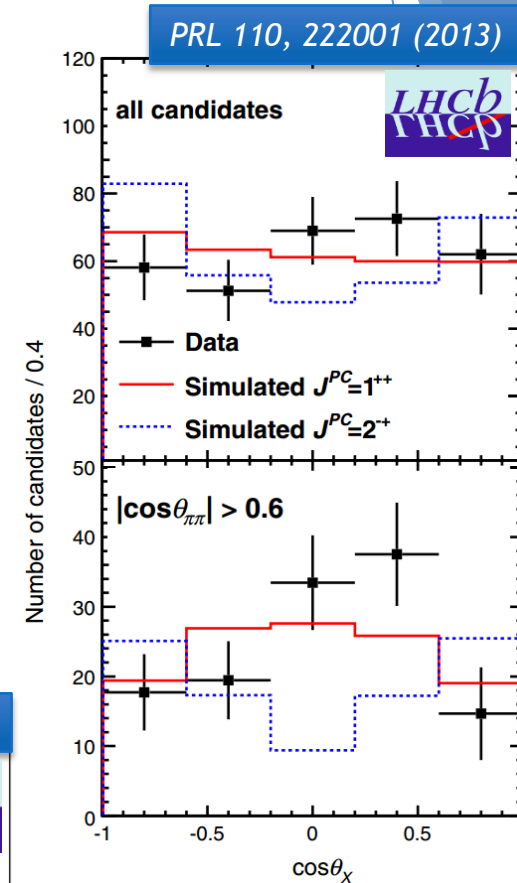
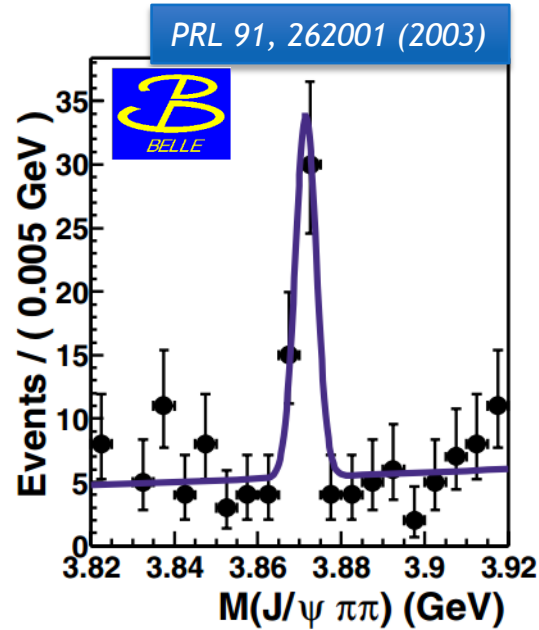

Observation of $e^+e^- \rightarrow \gamma X(3872)$

- ▶ Search for $\gamma X(3872)$ with $X(3872) \rightarrow \pi^+\pi^- J/\Psi$ at $E_{\text{cm}} = 4.23, 4.26$ and 4.36 GeV

- ▶ 6.3σ over all data

- ▶ Production in $Y(4260)$ is suggestive, but not conclusive

$$\frac{B(Y(4260) \rightarrow \gamma X(3872))}{B(Y(4260) \rightarrow \pi^+\pi^- J/\Psi)} \approx 0.1$$

- ▶ Measuring transitions between states is essential

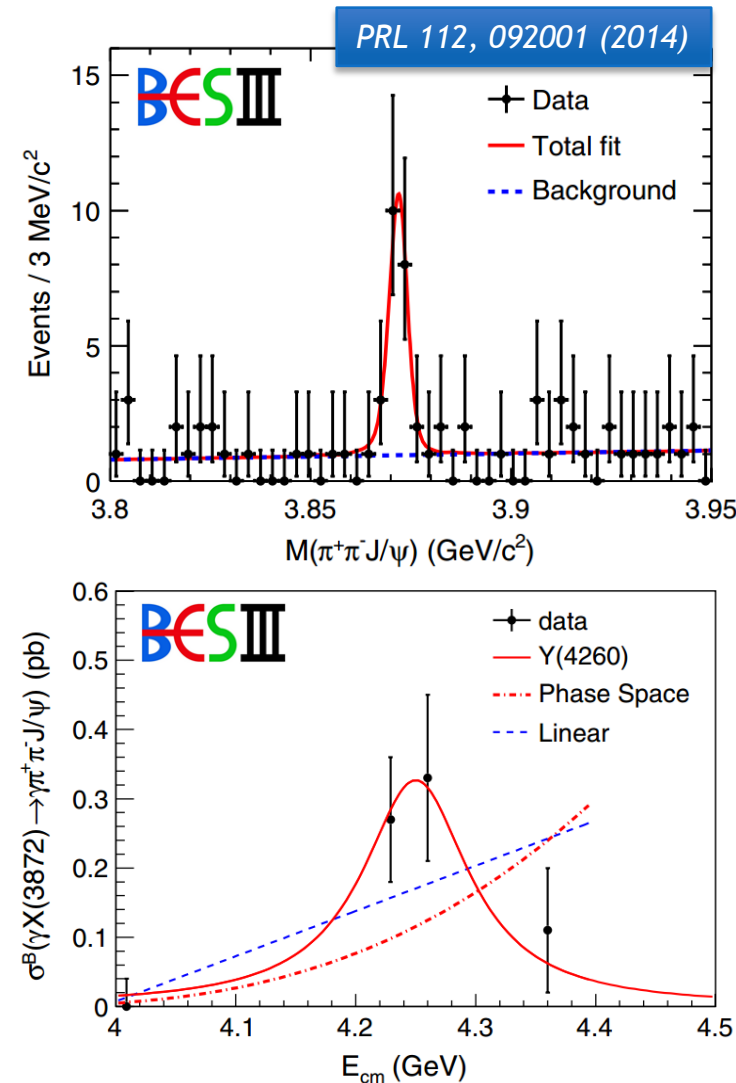

$$e^+e^- \rightarrow \omega\chi_{c0}$$

- ▶ Using data collected @4.23 and 4.26 GeV
- ▶ Fit with a single BW assumption, mass lower than 4.26 GeV
- ▶ No signal of $\omega\chi_{c1}$ or $\omega\chi_{c2}$ found between 4.19 and 4.42 GeV
- ▶ Disfavor Y(4260) is a $\omega\chi_{c1}$ molecule

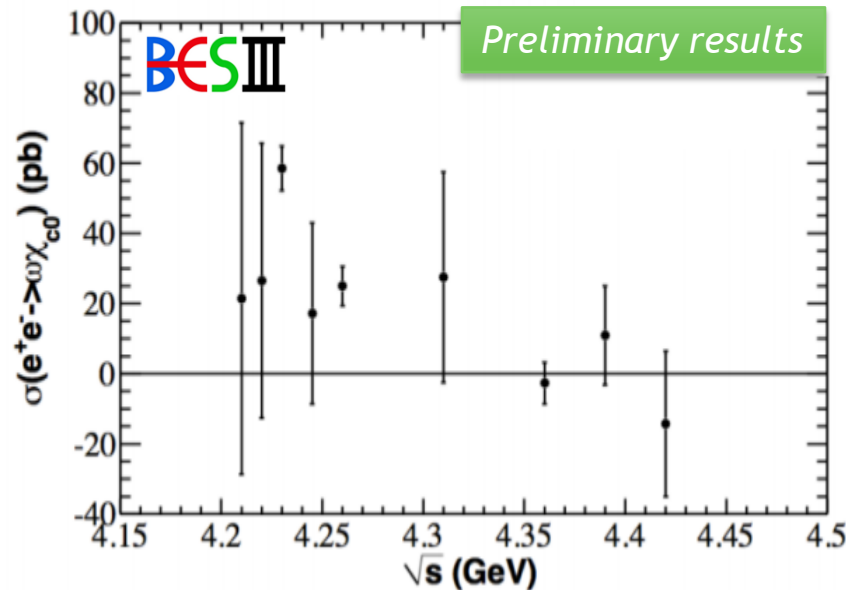
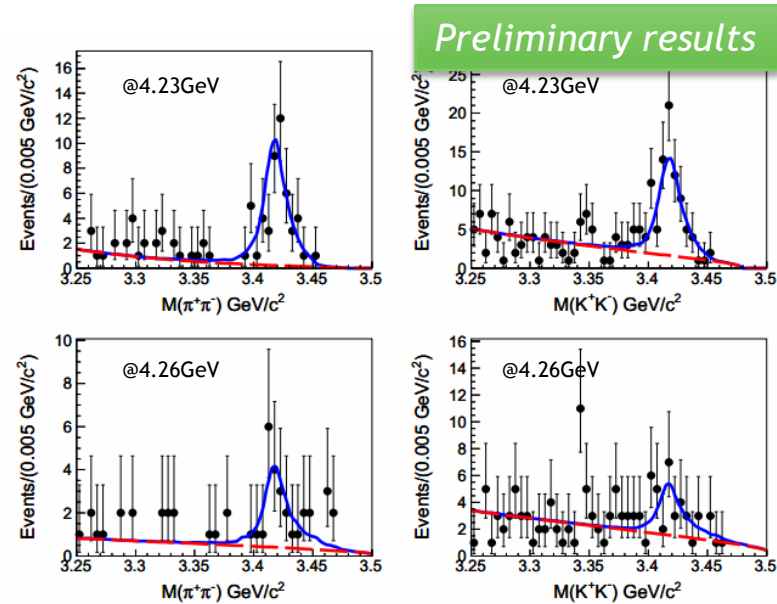

Light hadron spectroscopy at **BESIII**

Overview of light hadron spectroscopy

- ▶ Constituent Quark Model(CQM) has two types of hadrons
 - ▶ Mesons: $q\bar{q}$
 - ▶ Baryons: qqq
- ▶ QCD allows hadrons of other types
 - ▶ Multi-quark states: (more than 3 quarks)
 - ▶ Hybrids: $q\bar{q}g$
 - ▶ Glueballs: gg, ggg, \dots
- ▶ BESIII has collected the largest J/ψ and $\psi(2S)$ data sample in the world
 - ▶ 1.3 billion J/ψ events taken in 2009 and 2012
 - ▶ 0.5 billion $\psi(2S)$ events taken in 2009 and 2012
- ▶ Over the past few years, many new particles have been found or confirmed at BESIII
 - ▶ $X(p\bar{p}), X(1835), X(1870), X(1810), X(1840), X(2120), X(2370), \dots$

$\omega\phi$ threshold enhancement in $J/\psi \rightarrow \gamma\omega\phi$

- ▶ $J/\psi \rightarrow \gamma\omega\phi$ is a DOZI process, but has a similar branch ratio compared to that of $J/\psi \rightarrow \gamma\phi\phi$, an OZI process
 - ▶ Dynamical effect arising from intermediate meson re-scattering
 - ▶ A manifestation of $f_0(1710)$
 - ▶ Hadrons of new types: tetraquark, hybrid, glueball, ...

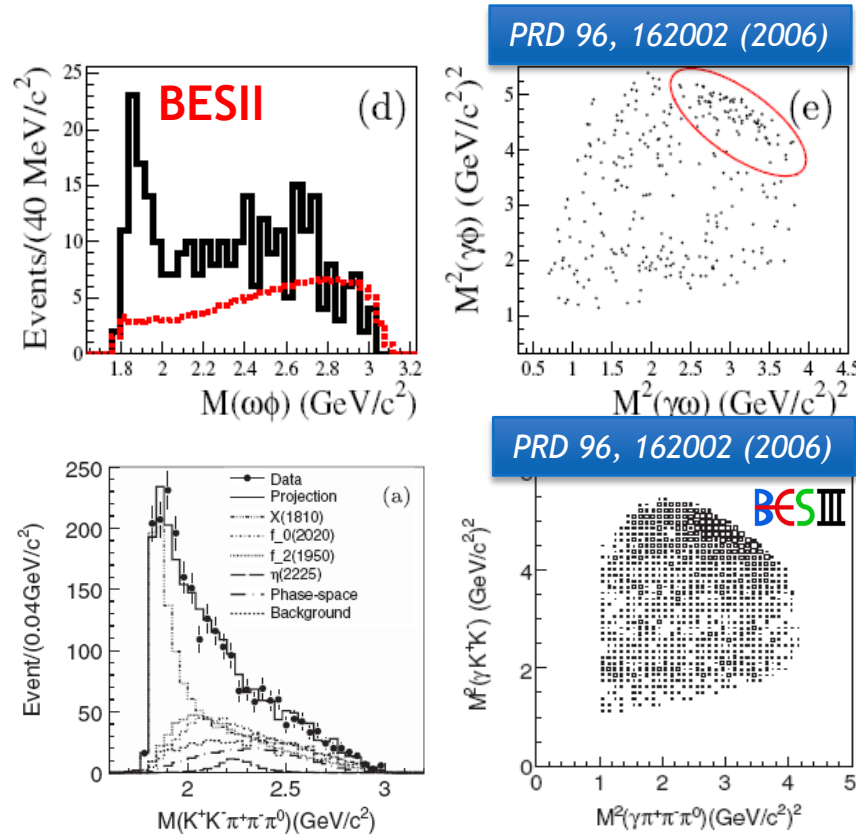

Resonance	J^{PC}	$M(\text{MeV}/c^2)$	$\Gamma(\text{MeV}/c^2)$	Events	ΔS	Δndf	Significance
$X(1810)$	0^{++}	1795 ± 7	95 ± 10	1319 ± 52	783	4	$>30\sigma$
$f_2(1950)$	2^{++}	1944	472	665 ± 40	211	2	20.4σ
$f_0(2020)$	0^{++}	1992	442	715 ± 45	100	2	13.9σ
$\eta(2225)$	0^{-+}	2226	185	70 ± 30	23	2	6.4σ
Coherent nonresonant component	0^{-+}	319 ± 24	45	2	9.1σ

Analysis of $J/\psi \rightarrow \gamma\eta\eta$

- ▶ Lattice QCD predicts the lowest lying 0^{++} glueball occurs in 1.5 to 1.7 GeV, and the lightest 2^{++} glueball has mass around 2.2 GeV
- ▶ $\eta\eta$ system: Even $^{++}$ states (mainly 0^{++} and 2^{++}), ideal place for search of scalar and tensor glueballs
 - ▶ Crystal Ball observed $f_0(1710)$ in $J/\psi \rightarrow \gamma\eta\eta$
 - ▶ Crystal Barrel observed $f_0(1500)$ in $p\bar{p} \rightarrow \pi^0\eta\eta$
 - ▶ Comparison to $\pi\pi$, $K\bar{K}$, $\eta\eta'$ system
- ▶ $J/\psi \rightarrow \gamma\eta\eta$ at BESIII
 - ▶ High statistics
 - ▶ EMC: CsI(T1) crystals, high performance
 - ▶ Low background

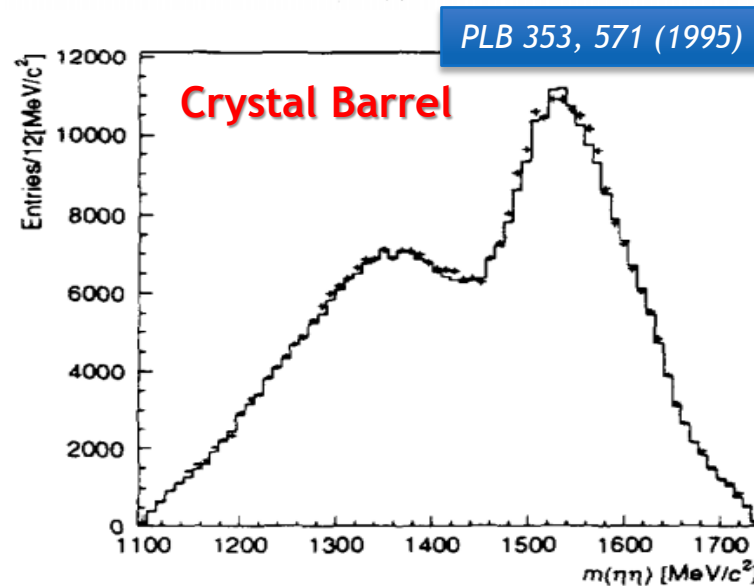
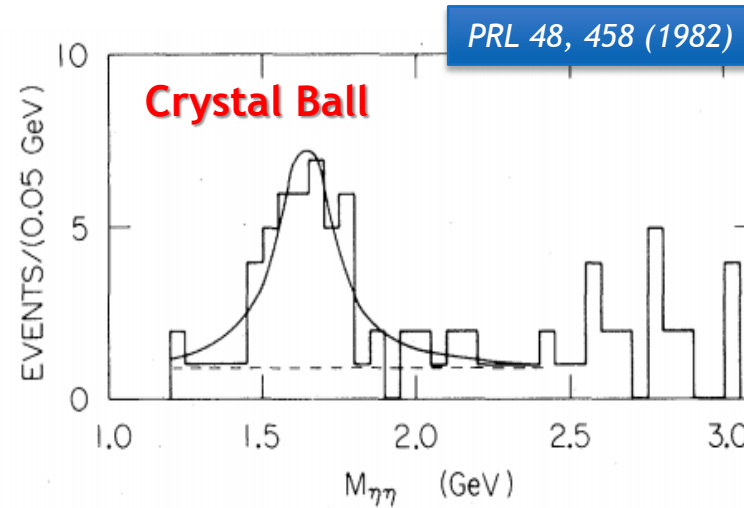

Partial Wave Analysis of $J/\psi \rightarrow \gamma\eta\eta$

- ▶ $f_0(1710)$ and $f_0(2100)$ are dominant scalars, $f_0(1500)$ exists
- ▶ $f_2'(1525)$ is the dominant tensor, $f_2(1810)$ and $f_2(2340)$ exist
- ▶ Production rate of $f_0(1500)$ is approximately one order smaller than that of $f_0(1710)$ and $f_0(2100)$
- ▶ Production rate of $f_0(1710)$ in radiative J/ψ decays is compatible with LQCD's prediction on that of a pure gauge scalar glueball.
- ▶ Large overlap between $f_0(1710)$ and a glueball?

Resonance	$B(J/\psi \rightarrow \gamma X \rightarrow \gamma\eta\eta)$	Significance
$f_0(1500)$	$(1.65^{+0.36}_{-0.31} {}^{+0.51}_{-1.40}) \times 10^{-5}$	8.2σ
$f_0(1710)$	$(2.35^{+0.13}_{-0.11} {}^{+1.24}_{-0.74}) \times 10^{-4}$	25.0σ
$f_0(2100)$	$(1.13^{+0.09}_{-0.10} {}^{+0.64}_{-0.28}) \times 10^{-4}$	13.9σ
$f_2'(1525)$	$(3.42^{+0.43}_{-0.51} {}^{+1.37}_{-1.30}) \times 10^{-5}$	11.0σ
$f_2(1810)$	$(5.40^{+0.60}_{-0.67} {}^{+3.42}_{-2.35}) \times 10^{-5}$	6.4σ
$f_2(2340)$	$(5.60^{+0.62}_{-0.65} {}^{+2.37}_{-2.07}) \times 10^{-5}$	7.6σ
0^{++} PHSP	$(1.47^{+0.01}_{-0.02}) \times 10^{-4}$	12.4σ

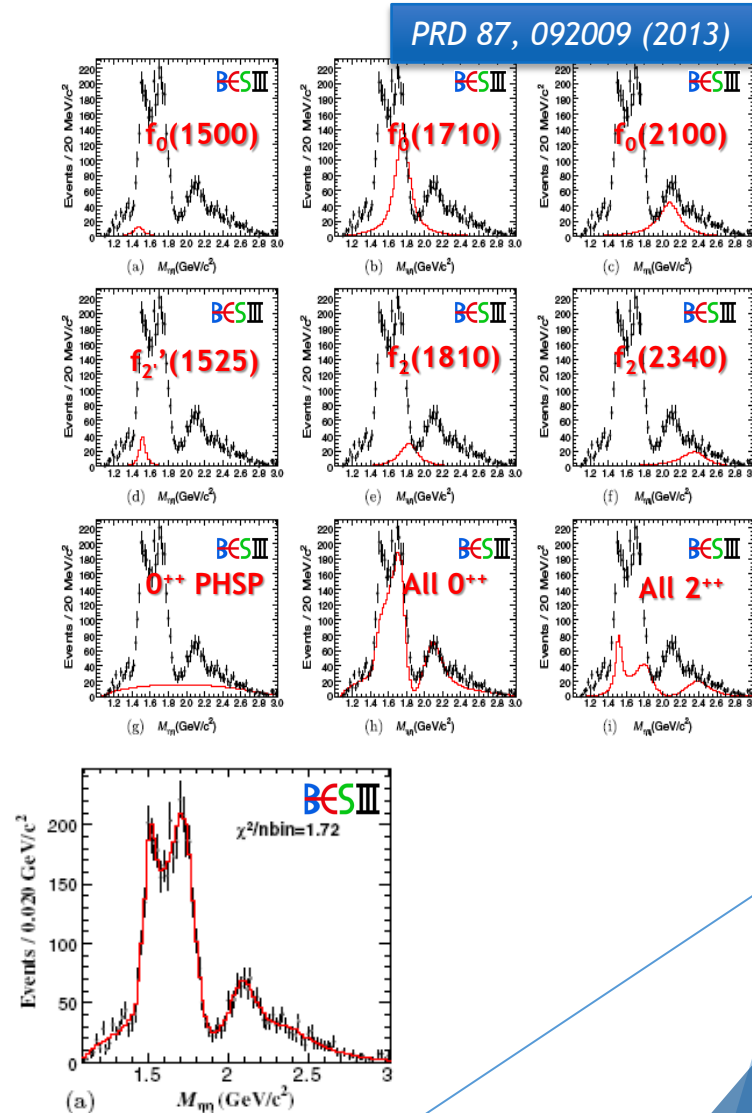

Observation of $\eta' \rightarrow \pi^+ \pi^- \pi^+ \pi^- (\pi^+ \pi^- \pi^0 \pi^0)$

- ▶ First observation the branching ratios
- ▶ Clearly support the model:
Chiral perturbation and Vector-meson dominance

$$B(\eta' \rightarrow \pi^+ \pi^- \pi^+ \pi^-) = (8.53 \pm 0.69 \pm 0.64) \times 10^{-5}$$

$$B(\eta' \rightarrow \pi^+ \pi^- \pi^0 \pi^0) = (1.82 \pm 0.35 \pm 0.18) \times 10^{-4}$$

PRL 112, 251801 (2014)

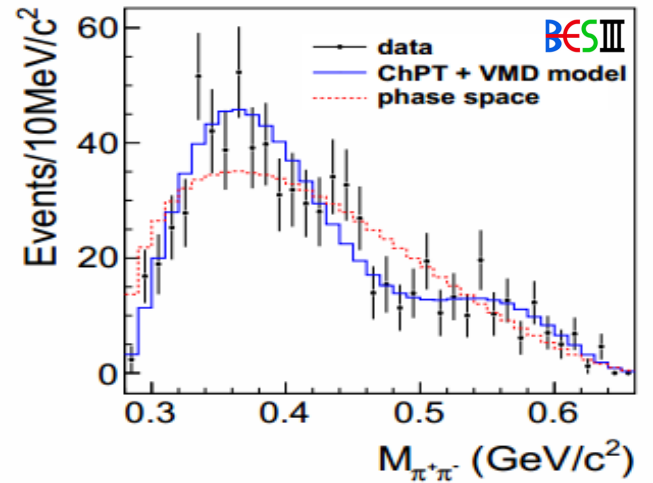
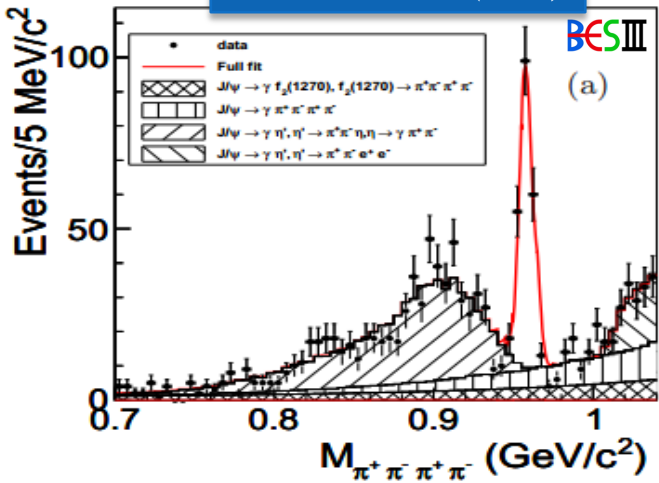
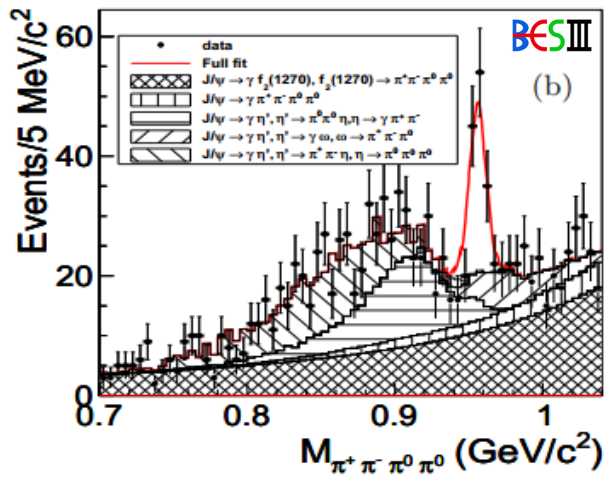

PWA of $\psi(2S) \rightarrow p\bar{p}\pi^0$

- ▶ Two new baryonic excited states are observed in PWA:
 $N(2300)$ [$J^P = 1/2^+$],
 $N(2570)$ [$J^P = 5/2^-$]
- ▶ $N(1885)$ or $N(2065)$ has not been found

Resonance	$M(\text{MeV}/c^2)$	$\Gamma(\text{MeV}/c^2)$	ΔS	ΔN_{dof}	Sig.
$N(1440)$	1390^{+11+21}_{-21-30}	$340^{+46+70}_{-40-156}$	72.5	4	11.5σ
$N(1520)$	1510^{+3+11}_{-7-9}	115^{+20+0}_{-15-40}	19.8	6	5.0σ
$N(1535)$	1535^{+9+15}_{-8-22}	120^{+20+0}_{-20-42}	49.4	4	9.3σ
$N(1650)$	1650^{+5+11}_{-5-30}	150^{+21+14}_{-22-50}	82.1	4	12.2σ
$N(1720)$	1700^{+30+32}_{-28-35}	$450^{+109+149}_{-94-44}$	55.6	6	9.6σ
$N(2300)$	$2300^{+40+109}_{-30-0}$	$340^{+30+110}_{-30-58}$	120.7	4	15.0σ
$N(2570)$	2570^{+19+34}_{-10-10}	250^{+14+69}_{-24-21}	78.9	6	11.7σ

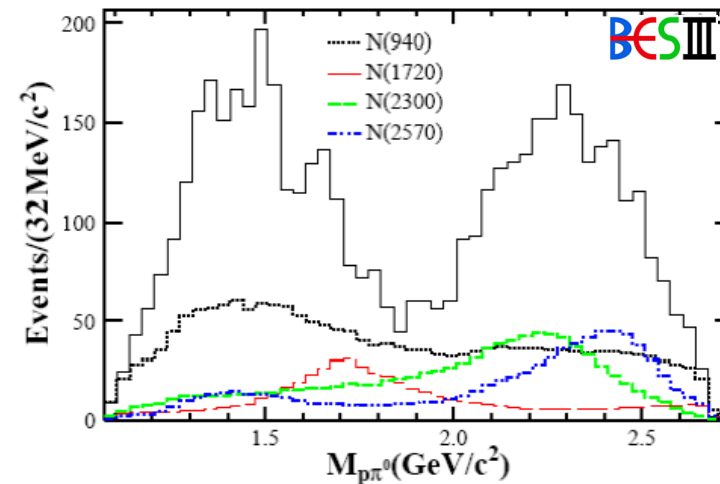
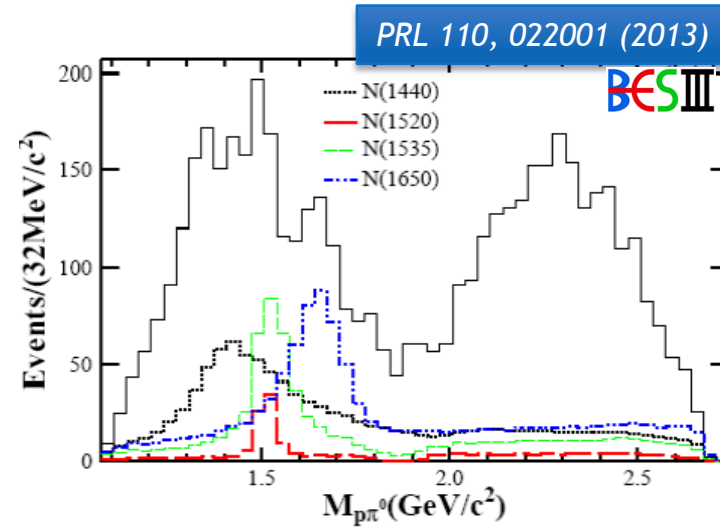

PWA of $\psi(2S) \rightarrow p\bar{p}\eta$

- ▶ $\psi(2S) \rightarrow N(1535)\bar{p}$ is dominant
- ▶ $J^P = 1/2^-$
- ▶ No evidence for a $p\bar{p}$ resonance that was observed by BESII and CLEO-c without PWA

PRD 88, 032010 (2013)

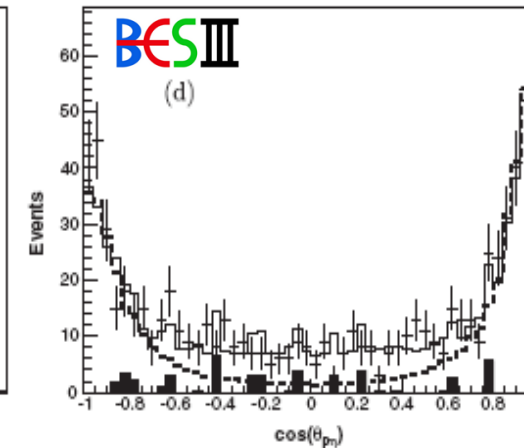
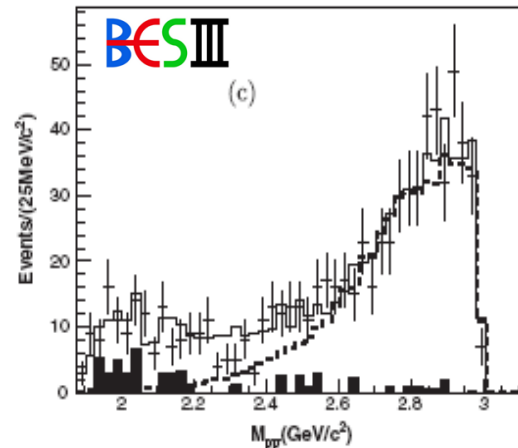
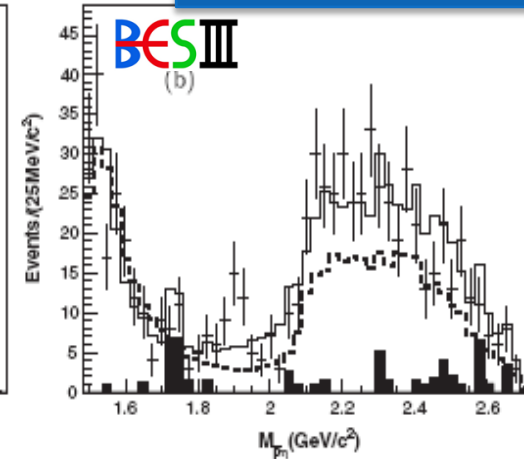
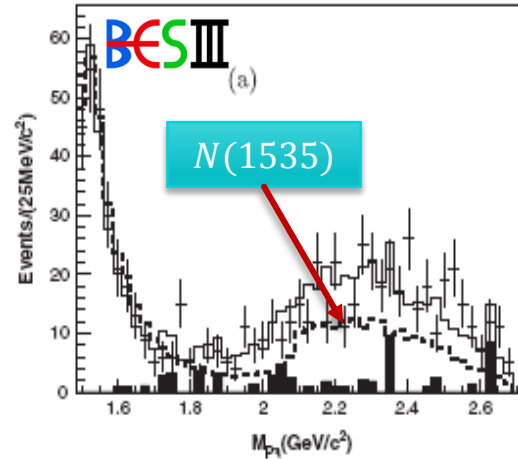

$$M = 1524 \pm 5^{+10}_{-4} \text{ MeV}$$

$$\Gamma = 130^{+27}_{-24} {}^{+57}_{-10} \text{ MeV}$$

X(1840) in $J/\psi \rightarrow \gamma 3(\pi^+ \pi^-)$

- ▶ A distinct enhancement can be clearly seen on mass spectrum of $3(\pi^+ \pi^-)$ around 1.84 GeV
- ▶ Mass is consistent with that of X(1835), but the width is much smaller
- ▶ A new decay modes of X(1835)?
 - ▶ X(1835) is likely to have similar properties as η_c . $3(\pi^+ \pi^-)$ is a relatively large decay mode of η_c , also for X(1835)?

$$M = 1842.2 \pm 4.2_{-2.6}^{+7.1} \text{ MeV}$$

$$\Gamma = 82 \pm 14 \pm 11 \text{ MeV}$$

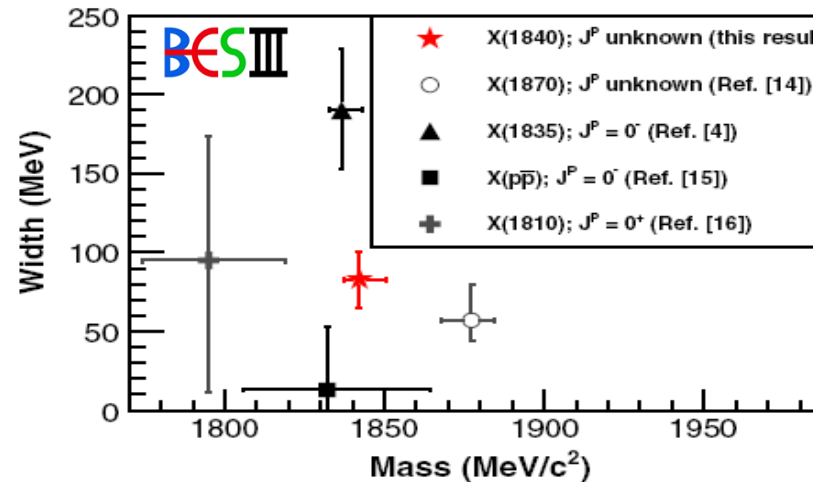
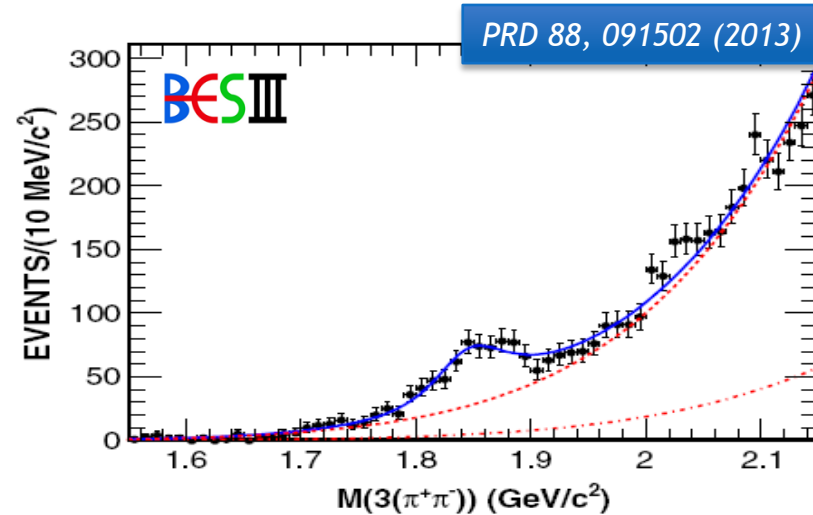

X(1840) in $J/\psi \rightarrow \gamma 3(\pi^+ \pi^-)$

- ▶ X(1835) is likely to have similar properties as η_c .
 - ▶ $3(\pi^+ \pi^-)$ is a relatively large decay mode of η_c , also for X(1835)?
- ▶ A distinct enhancement can be clearly seen on mass spectrum of $3(\pi^+ \pi^-)$ around 1.84 GeV
- ▶ Mass is consistent with that of X(1835), but the width is much smaller
- ▶ A new decay modes of X(1835)?

$$M = 1842.2 \pm 4.2_{-2.6}^{+7.1} \text{ MeV}$$

$$\Gamma = 82 \pm 14 \pm 11 \text{ MeV}$$

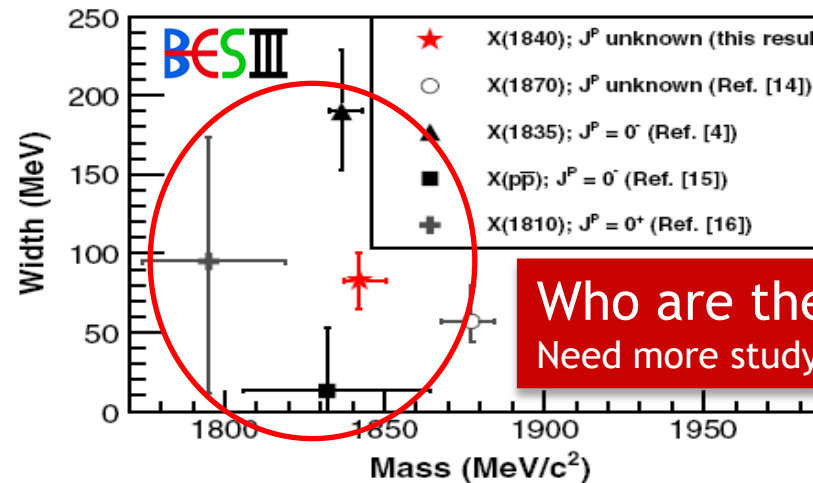
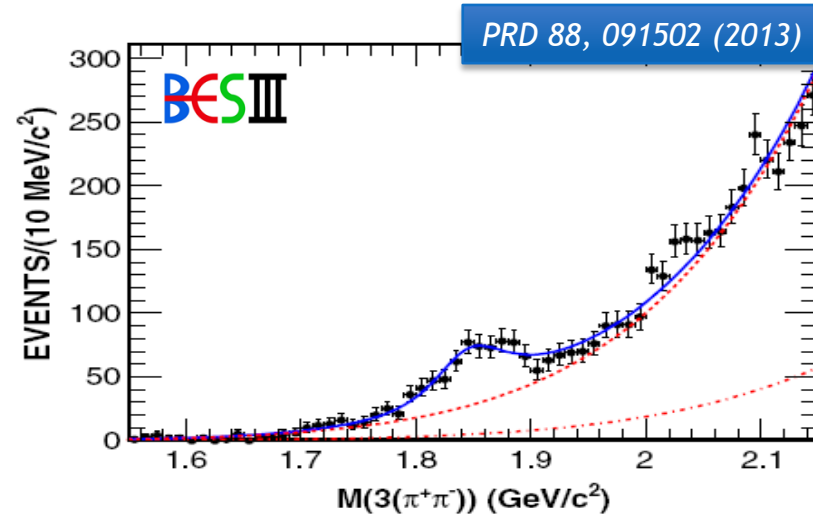

Who are they?
Need more study: more data, PWA...

Summary of Observations

- ▶ Lots of XYZ results at BESIII
 - ▶ Charged Z particles are observed, very close to the DD^* and D^*D^* threshold, at least four quark exotics
 - ▶ New production mode of $X(3872)$
 - ▶ Y resonances are very likely related to these particles' production
 - ▶ Observation of $e^+e^- \rightarrow \omega\chi_{c0}$, no $\omega\chi_{c1}$ or $\omega\chi_{c2}$ @ [4.19, 4.42 GeV]

Summary of Observations

- ▶ Lots of XYZ results at BESIII
 - ▶ Charged Z particles are observed, very close to the DD^* and D^*D^* threshold, at least four quark exotics
 - ▶ New production mode of $X(3872)$
 - ▶ Y resonances are very likely related to these particles' production
 - ▶ Observation of $e^+e^- \rightarrow \omega\chi_{c0}$, no $\omega\chi_{c1}$ or $\omega\chi_{c2}$ @ [4.19, 4.42 GeV]
- ▶ By using huge data samples collected for charmonium decays at BESIII, a lot of results have been obtained,
 - ▶ $X(1810)$ is confirmed
 - ▶ First observation of $X(1840) \rightarrow 3(\pi^+\pi^-)$
 - ▶ Study of $\eta\eta$ system
 - ▶ Observation of $\eta' \rightarrow \pi^+\pi^-\pi^+\pi^-(\pi^+\pi^-\pi^0\pi^0)$
 - ▶ Study of N^* baryons in $\psi(2S) \rightarrow p\bar{p}\pi^0, p\bar{p}\eta$

Summary of Observations

- ▶ Lots of XYZ results at BESIII
 - ▶ Charged Z particles are observed, very close to the DD^* and D^*D^* threshold, at least four quark exotics
 - ▶ New production mode of $X(3872)$
 - ▶ Y resonances are very likely related to these particles' production
 - ▶ Observation of $e^+e^- \rightarrow \omega\chi_{c0}$, no $\omega\chi_{c1}$ or $\omega\chi_{c2}$ @ [4.19, 4.42 GeV]
- ▶ By using huge data samples collected for charmonium decays at BESIII, a lot of results have been obtained,
 - ▶ $X(1810)$ is confirmed
 - ▶ First observation of $X(1840) \rightarrow 3(\pi^+\pi^-)$
 - ▶ Study of $\eta\eta$ system
 - ▶ Observation of $\eta' \rightarrow \pi^+\pi^-\pi^+\pi^-(\pi^+\pi^-\pi^0\pi^0)$
 - ▶ Study of N^* baryons in $\psi(2S) \rightarrow p\bar{p}\pi^0, p\bar{p}\eta$
- ▶ With more data sample accumulated at BESIII, exciting future is ahead!



Thanks a lot!